

# ECS-9200/9100 USER

Quad Core Intel® Xeon® / Core™ i7/ i5/ i3 Fanless Embedded System  
High Performance, Rugged, Expandable, -40°C to 75°C Extended Temp

# Manual

## Record of Revision

---

Version	Date	Page	Description	Remark
1.0	03/24/2017	All	Official Release	
1.1	05/09/2017	92	Update	
1.2	09/19/2017	20	Update	
1.3	11/16/2018	All	Update	
1.4	03/22/2021	3, 5, 7, 10, 12, 14, 26, 27	Update	
1.5	05/23/2022	113-115	Update	
1.6	05/31/2023	vi, 20, 48, 103	Update	

## Disclaimer

This manual is released by Vecow Co., Ltd. for reference purpose only. All product offerings and specifications are subject to change without prior notice. It does not represent commitment of Vecow Co., Ltd. Vecow shall not be liable for direct, indirect, special, incidental, or consequential damages arising out of the use of the product or documentation or any infringements upon the rights of third parties, which may result from such use.

## Declaration of Conformity

**FCC** This equipment has been tested and found to comply with the limits for a Class A digital device, pursuant to part 15 of the FCC Rules. These limits are designed to provide reasonable protection against harmful interference when the equipment is operated in a commercial environment. This equipment generates, uses, and can radiate radio frequency energy, and if it is not installed and used in accordance with the instruction manual, it may cause harmful interference to radio communications. Operation of this equipment in a residential area is likely to cause harmful interference in which case the user will be required to correct the interference at his own expense.

**CE** The products described in this manual complies with all applicable European Union (CE) directives if it has a CE marking. For computer systems to remain CE compliant, only CE-compliant parts may be used. Maintaining CE compliance also requires proper cable and cabling techniques.

## Copyright and Trademarks

This document contains proprietary information protected by copyright. No part of this publication may be reproduced in any form or by any means, electric, photocopying, recording or otherwise, without prior written authorization by Vecow Co., Ltd. The rights of all the brand names, product names, and trademarks belong to their respective owners.

## Order Information

Part Number	Description
ECS-9210M	ECS-9200, 6 GigE LAN w/4 M12 PoE <sup>+</sup> , 2 SSD Tray, 1 PCIe x16, 8 USB 3.0, 4 COM, 3 SIM, 32 Isolated DIO
ECS-9210	ECS-9200, 6 GigE LAN w/4 PoE <sup>+</sup> , 2 SSD Tray, 1 PCIe x16, 8 USB 3.0, 4 COM, 3 SIM, 32 Isolated DIO
ECS-9201M	ECS-9200, 6 GigE LAN w/4 M12 PoE <sup>+</sup> , 2 SSD Tray, 1 PCI, 8 USB 3.0, 4 COM, 3 SIM, 32 Isolated DIO
ECS-9201	ECS-9200, 6 GigE LAN w/4 PoE <sup>+</sup> , 2 SSD Tray, 1 PCI, 8 USB 3.0, 4 COM, 3 SIM, 32 Isolated DIO
ECS-9110	ECS-9100, 2 GigE LAN, 2 SSD Tray, 1 PCIe x16, 8 USB 3.0, 4 COM, 3 SIM, 16 GPIO
ECS-9101	ECS-9100, 2 GigE LAN, 2 SSD Tray, 1 PCI, 8 USB 3.0, 4 COM, 3 SIM, 16 GPIO

## Order Accessories

Part Number	Description
E3-1275 v6	7th Gen Intel® Xeon® E3-1275 v6 Processor (8M Cache, up to 4.20GHz, 80W)
E3-1275 v5	6th Gen Intel® Xeon® E3-1275 v5 Processor (8M Cache, up to 4.00GHz, 80W)
E3-1225 v5	6th Gen Intel® Xeon® E3-1225 v5 Processor (6M Cache, up to 3.70GHz, 80W)
E3-1268L v5	6th Gen Intel® Xeon® E3-1268L v5 Processor (8M Cache, up to 3.40GHz, 35W)
i7-7700	7th Gen Intel® Core™ i7-7700 Processor (8M Cache, up to 4.20GHz, 65W)
i7-7700T	7th Gen Intel® Core™ i7-7700T Processor (8M Cache, up to 3.80GHz, 35W)
i7-6700	6th Gen Intel® Core™ i7-6700 Processor (8M Cache, up to 4.00GHz)
i7-6700TE	6th Gen Intel® Core™ i7-6700TE Processor (8M Cache, up to 3.40GHz)

<b>Part Number</b>	<b>Description</b>
i5-7500	7th Gen Intel® Core™ i5-7500 Processor (6M Cache, up to 3.80GHz, 65W)
i5-7500T	7th Gen Intel® Core™ i5-7500T Processor (6M Cache, up to 3.30GHz, 35W)
i5-6500	6th Gen Intel® Core™ i5-6500 Processor (6M Cache, up to 3.60GHz)
i5-6500TE	6th Gen Intel® Core™ i5-6500TE Processor (6M Cache, up to 3.30GHz)
i3-7101E	7th Gen Intel® Core™ i3-7101E Processor (3M Cache, up to 3.90GHz, 65W)
i3-7101TE	7th Gen Intel® Core™ i3-7101TE Processor (3M Cache, up to 3.40GHz, 35W)
i3-6100	6th Gen Intel® Core™ i3-6100 Processor (3M Cache, 3.70GHz)
i3-6100TE	6th Gen Intel® Core™ i3-6100TE Processor (4M Cache, 2.70GHz)
DDR4 32G	Certified DDR4 32GB 2666MHz RAM
DDR4 16G	Certified DDR4 16GB 2400/2133 MHz RAM
DDR4 8G	Certified DDR4 8GB 2400/2133 MHz RAM
DDR4 4G	Certified DDR4 4GB 2400/2133 MHz RAM
PWA-280W-WT	280W, 24V, 85V AC to 264V AC Power Adapter with 3-pin Terminal Block (7.62mm pitch), Wide Temperature -30°C to +70°C
PWA-160W-WT	160W, 24V, 85V AC to 264V AC Power Adapter with 3-pin Terminal Block (7.62mm pitch), Wide Temperature -30°C to +70°C
PWA-120W	120W, 24V, 90V AC to 264V AC Power Adapter
VESA Mount	VESA Mounting Kit
Rack Mount	2U Rackmount Kit
TMK2-20P-100	Terminal Block 20-pin to Terminal Block 20-pin Cable, 100cm
TMK2-20P-500	Terminal Block 20-pin to Terminal Block 20-pin Cable, 500cm
TMB-TMBK-20P	Terminal Board with One 20-pin Terminal Block Connector and DIN-Rail Mounting
4G Module	Mini PCIe 4G/GPS Module with Antenna
WiFi & Bluetooth	WiFi & Bluetooth Module with Antenna

# Table of Contents

<b>CHAPTER 1</b>	<b>GENERAL INTRODUCTION</b>	<b>1</b>
1.1	Overview	1
1.2	Features	2
1.3	Product Specification	2
1.3.1	Specifications of ECS-9210M	2
1.3.2	Specifications of ECS-9210	4
1.3.3	Specifications of ECS-9201M	7
1.3.4	Specifications of ECS-9201	9
1.3.5	Specifications of ECS-9110	12
1.3.6	Specifications of ECS-9101	14
1.4	Supported CPU List	16
1.5	Mechanical Dimension	17
1.5.1	Dimensions of ECS-9210M	17
1.5.2	Dimensions of ECS-9210	17
1.5.3	Dimensions of ECS-9201M	18
1.5.4	Dimensions of ECS-9201	18
1.5.5	Dimensions of ECS-9110	19
1.5.6	Dimensions of ECS-9101	19
<b>CHAPTER 2</b>	<b>GETTING TO KNOW YOUR ECS-9200/9100</b>	<b>20</b>
2.1	Packing List	20
2.2	Front Panel I/O & Functions	21
2.3	Rear Panel I/O & Functions	28
2.4	Main Board Expansion Connectors	36
2.5	Main Board Jumper & DIP Switch Settings	48
2.6	Ignition Control	52
<b>CHAPTER 3</b>	<b>SYSTEM SETUP</b>	<b>56</b>
3.1	How to Open Your ECS-9200/9100	56
3.2	Installing CPU	60

3.3	Installing DDR4 SO-DIMM Modules	63
3.4	Installing Mini PCIe Card	64
3.5	Installing CFast Card	65
3.6	Installing SIM Card	66
3.7	Installing PCI/PCIe Card	67
3.8	Installing SSD/HDD	69
3.9	Installing M.2	71
3.10	Mounting Your ECS-9200/9100	72
<b>CHAPTER 4</b>	<b>BIOS SETUP</b>	<b>78</b>
4.1	Entering BIOS SETUP	78
4.2	Main	79
4.3	Advanced	79
4.4	Chipset	88
4.5	Security	93
4.6	Boot	94
4.7	Save & Exit	95
<b>APPENDIX A</b>	<b>Isolated DIO Guide</b>	<b>96</b>
<b>APPENDIX B</b>	<b>Software Functions</b>	<b>99</b>
<b>APPENDIX C</b>	<b>RAID Installation Guide</b>	<b>102</b>
<b>APPENDIX D</b>	<b>Power Consumption</b>	<b>106</b>
<b>APPENDIX E</b>	<b>Supported Memory &amp; Storage List</b>	<b>110</b>
<b>APPENDIX F</b>	<b>Install Win11 (BIOS TPM Setting)</b>	<b>113</b>

# 1

## GENERAL INTRODUCTION

### 1.1 Overview

Vecow ECS-9200/9100 Series is a high-performance, all-in-one integrated, expandable Fanless Embedded Workstation System. LGA1151 Socket supports Quad Core 7th/6th Generation Intel® Xeon®/Core™ i7/i5/i3 processor (Kaby Lake-S/Skylake-S) running with workstation-grade Intel® C236 chipset, dual channel DDR4 2400MHz up to 64GB ECC memory, advanced Intel® HD Graphics 630/530 supporting DirectX 12, OpenGL 4.4 and OpenCL 2.0 API, onboard DVI-I, DVI-D and DisplayPort display interface for Ultra HD 4K resolution, ECS-9200/9100 offers leading CPU performance, power efficiency, and graphics performance; PCIe 3.0 (8GT/s), Multiple SATA III (6Gbps), USB 3.0 (5Gbps), PoE (1Gbps) LAN and multiple wireless connections make seamless high-speed data conveying possible. Vecow ECS-9200/9100 Series Expandable Fanless Embedded System delivers outstanding system performance, power productivity and flexible manageability for performance-driven embedded computing applications.

All-in-one and cable-less designs, fanless -40°C to 75°C extended operating temperature, 6 GigE LAN ports with 4 IEEE 802.3at (25.5W/48V) PoE<sup>+</sup> without additional power connections, 2 Front-access 2.5" SSD/HDD trays, 1 patented easy-swap PCI/PCIe slot, 3 external SIM card sockets for WiFi/4G/3G/LTE/GPRS/UMTS, 1 onboard M.2 socket, 1 front-access CFast socket, 2 SATA III supports software RAID functions, 8 external USB 3.0, 4 COM RS-232/422/485, 32 Isolated DIO, 6V to 36V wide range power input with 80V surge protection, configurable ignition power control, PCIe x16 expansion supports up to 160W power budget, smart remote management features, remote power switch, EN50155 and EN50121-3-2 compliant, Vecow ECS-9200/9100 Series Expandable Rugged Embedded System serves outstanding system performance, versatile I/O functions, flexible expansion features, and rugged reliability for embedded applications.

With outstanding system performance, all-in-one integrated features, smarter manageability, flexible expandability, great mobile availability, 6V to 36V power input with 80V surge protection, ignition power control, intelligent circus protection and more rugged reliability, Vecow ECS-9200/9100 Series Expandable Fanless Embedded System is your superb solution for Machine Vision, Rolling Stock, Intelligent Surveillance, Smart Manufacturing, ITS, Intelligent Automation, Vehicle Computing, and any Industry 4.0 performance-driven real-time embedded computing applications.



## 1.2 Features

- LGA 1151 Socket supports Quad Core 7th/6th Generation Intel® Xeon®/Core™ i7/i5/i3 Processor (Kaby Lake-S/Skylake-S) with Intel® C236 Chipset
- Fanless, -40°C to 75°C Extended Operating Temperature
- 2 DDR4 2400/2133 MHz Memory, up to 64GB
- 6 Independent GigE LAN with 4 M12 IEEE 802.3at PoE<sup>+</sup>, iAMT 11.0 supported
- Expansion : 1 PCI/PCIe x16, 3 Mini PCIe/mSATA, 1 M.2
- PCIe x16 expansion supports up to 160W Power Budget
- Storage : 2 Front-access 2.5" SSD Tray, 1 CFast Socket, 2 SATA III
- DVI-I, DVI-D and DisplayPort display interfaces, up to 4K display
- 32 Isolated DIO, 8 USB 3.0, 4 COM
- 3 External SIM Card Socket support WiFi/4G/3G/LTE/GPRS/UMTS
- 6V to 36V DC Power Input with 80V Surge Protection
- Configurable Ignition Power Control

## 1.3 Product Specification

### 1.3.1 Specifications of ECS-9210M

System	
Processor	Quad Core 7th/6th Intel® Xeon®/Core™ i7/i5/i3 Processor (Kaby Lake-S/Skylake-S)
Chipset	Intel® C236
BIOS	AMI
SIO	IT8786E
Memory	<ul style="list-style-type: none"><li>• DDR4 2400/2133 MHz</li><li>• Up to 64GB</li><li>• 2 260-pin SO-DIMM Socket</li></ul>
I/O Interface	
Serial	4 COM RS-232/422/485 with auto flow control (ESD 8KV)
USB	<ul style="list-style-type: none"><li>• 8 External USB 3.0 (4 Front, 4 Rear)</li><li>• 1 USB 2.0 (Internal)</li></ul>
Isolated DIO	32 Isolated DIO (16 DI, 16 DO)
LED	Power, HDD, Wireless, PoE
SIM Card	3 External SIM Card Socket

<b>Expansion</b>	
Mini PCIe	3 Full-size for PCIe/USB/External SIM Card/mSATA
PCI/PCIe	1 PCIe x16 Slot supports up to 160W Power Budget
M.2	1 M.2 Socket (Key ID : M)
<b>Graphics</b>	
Graphics Processor	Intel® HD Graphics P630/630/P530/530
Interface	<ul style="list-style-type: none"> <li>• DVI-I : Up to 1920 x 1200 @ 60Hz</li> <li>• DVI-D : Up to 1920 x 1200 @ 60Hz</li> <li>• DisplayPort : Up to 4096 x 2304 @ 60Hz</li> </ul>
<b>Storage</b>	
SATA	2 SATA III (6Gbps) support software RAID 0, 1
mSATA	3 SATA III (Mini PCIe Type, 6Gbps)
Storage Device	<ul style="list-style-type: none"> <li>• 1 CFast Socket, Push-in/Push-out Ejector</li> <li>• 2 Front-access 2.5" SSD/HDD Tray</li> </ul>
<b>Audio</b>	
Audio Codec	Realtek ALC888S-VD, 7.1 Channel HD Audio
Audio Interface	1 Mic-in, 1 Line-out
<b>Ethernet</b>	
LAN 1	Intel® I219LM GigE LAN supports iAMT 11.0
LAN 2	Intel® I210 GigE LAN
<b>PoE (M12)</b>	
LAN 3	GigE IEEE 802.3at (25.5W/48V) PoE <sup>+</sup> by Intel® I210, M12 Connector
LAN 4	GigE IEEE 802.3at (25.5W/48V) PoE <sup>+</sup> by Intel® I210, M12 Connector
LAN 5	GigE IEEE 802.3at (25.5W/48V) PoE <sup>+</sup> by Intel® I210, M12 Connector
LAN 6	GigE IEEE 802.3at (25.5W/48V) PoE <sup>+</sup> by Intel® I210, M12 Connector
<b>Power</b>	
Input Voltage	6V to 36V, DC-in
Power Interface	3-pin Terminal Block : V+, V-, Frame Ground
Ignition Control	16 Mode (Internal)
Remote Switch	3-pin Terminal Block : On, Off, IGN
Surge Protection	Up to 80V/1ms Transient Power

Others	
TPM	Optional Infineon SLB9665 supports TPM 2.0, LPC interface
Watchdog Timer	Reset : 1 to 255 sec./min. per step
Smart Management	Wake on LAN, PXE supported
HW Monitor	Monitoring temperature, voltages. Auto throttling control when CPU overheats.
Software Support	
OS	Windows 10, Windows 8.1, Windows 7, Linux
Mechanical	
Dimensions (WxDxH)	260mm x 215mm x 79mm (10.2" x 8.5" x 3.1")
Weight	4.2 kg (9.26 lb)
Mounting	<ul style="list-style-type: none"> <li>• Wallmount by mounting bracket</li> <li>• DIN Rail Mount (Optional)</li> <li>• 2U Rackmount (Optional)</li> </ul>
Environment	
Operating Temperature	<b>35W TDP CPU :</b> <ul style="list-style-type: none"> <li>• Core™ i7, i5, i3 : -40°C to 75°C (-40°F to 167°F)</li> <li>• Xeon® E3-1268L v5 : -40°C to 70°C (-40°F to 158°F)</li> </ul> <b>65W TDP CPU :</b> <ul style="list-style-type: none"> <li>• Core™ i7, i5, i3 : -40°C to 55°C (-40°F to 131°F)</li> </ul> <b>80W TDP CPU :</b> <ul style="list-style-type: none"> <li>• Xeon® E3-1275 v6, E3-1275 v5, E3-1225 v5 : -40°C to 45°C (-40°F to 113°F)</li> </ul>
Storage Temperature	-40°C to 85°C (-40°F to 185°F)
Humidity	5% to 95% Humidity, non-condensing
Relative Humidity	95% at 75°C
Shock	<ul style="list-style-type: none"> <li>• IEC 60068-2-27</li> <li>• SSD : 50G @ Wallmount, Half-sine, 11ms</li> </ul>
Vibration	<ul style="list-style-type: none"> <li>• IEC 60068-2-64</li> <li>• SSD : 5Grms, 5Hz to 500Hz, 3 Axis</li> </ul>
EMC	CE, FCC, EN50155, EN50121-3-2

### 1.3.2 Specifications of ECS-9210

System	
Processor	Quad Core 7th/6th Intel® Xeon®/Core™ i7/i5/i3 Processor (Kaby Lake-S/Skylake-S)
Chipset	Intel® C236
BIOS	AMI

SIO	IT8786E
Memory	<ul style="list-style-type: none"> <li>• DDR4 2400/2133 MHz</li> <li>• Up to 64GB</li> <li>• 2 260-pin SO-DIMM Socket</li> </ul>
<b>I/O Interface</b>	
Serial	4 COM RS-232/422/485 with auto flow control (ESD 8KV)
USB	<ul style="list-style-type: none"> <li>• 8 External USB 3.0 (4 Front, 4 Rear)</li> <li>• 1 USB 2.0 (Internal)</li> </ul>
Isolated DIO	32 Isolated DIO (16 DI, 16 DO)
LED	Power, HDD, Wireless, PoE
SIM Card	3 External SIM Card Socket
<b>Expansion</b>	
Mini PCIe	3 Full-size for PCIe/USB/External SIM Card/mSATA
PCI/PCIe	1 PCIe x16 Slot supports up to 160W Power Budget
M.2	1 M.2 Socket (Key ID : M)
<b>Graphics</b>	
Graphics Processor	Intel® HD Graphics P630/630/P530/530
Interface	<ul style="list-style-type: none"> <li>• DVI-I : Up to 1920 x 1200 @ 60Hz</li> <li>• DVI-D : Up to 1920 x 1200 @ 60Hz</li> <li>• DisplayPort : Up to 4096 x 2304 @ 60Hz</li> </ul>
<b>Storage</b>	
SATA	2 SATA III (6Gbps) support software RAID 0, 1
mSATA	3 SATA III (Mini PCIe Type, 6Gbps)
Storage Device	<ul style="list-style-type: none"> <li>• 1 CFast Socket, Push-in/Push-out Ejector</li> <li>• 2 Front-access 2.5" SSD/HDD Tray</li> </ul>
<b>Audio</b>	
Audio Codec	Realtek ALC888S-VD, 7.1 Channel HD Audio
Audio Interface	1 Mic-in, 1 Line-out
<b>Ethernet</b>	
LAN 1	Intel® I219LM GigE LAN supports iAMT 11.0
LAN 2	Intel® I210 GigE LAN
<b>PoE</b>	
LAN 3	GigE IEEE 802.3at (25.5W/48V) PoE <sup>+</sup> by Intel® I210
LAN 4	GigE IEEE 802.3at (25.5W/48V) PoE <sup>+</sup> by Intel® I210
LAN 5	GigE IEEE 802.3at (25.5W/48V) PoE <sup>+</sup> by Intel® I210
LAN 6	GigE IEEE 802.3at (25.5W/48V) PoE <sup>+</sup> by Intel® I210

<b>Power</b>	
Input Voltage	6V to 36V, DC-in
Power Interface	3-pin Terminal Block : V+, V-, Frame Ground
Ignition Control	16 Mode (Internal)
Remote Switch	3-pin Terminal Block : On, Off, IGN
Surge Protection	Up to 80V/1ms Transient Power
<b>Others</b>	
TPM	Optional Infineon SLB9665 supports TPM 2.0, LPC interface
Watchdog Timer	Reset : 1 to 255 sec./min. per step
Smart Management	Wake on LAN, PXE supported
HW Monitor	Monitoring temperature, voltages. Auto throttling control when CPU overheats.
<b>Software Support</b>	
OS	Windows 10, Windows 8.1, Windows 7, Linux
<b>Mechanical</b>	
Dimensions (WxDxH)	260mm x 215mm x 79mm (10.2" x 8.5" x 3.1")
Weight	4.2 kg (9.26 lb)
Mounting	<ul style="list-style-type: none"> <li>• Wallmount by mounting bracket</li> <li>• DIN Rail Mount (Optional)</li> <li>• 2U Rackmount (Optional)</li> </ul>
<b>Environment</b>	
Operating Temperature	<b>35W TDP CPU :</b> <ul style="list-style-type: none"> <li>• Core™ i7, i5, i3 : -40°C to 75°C (-40°F to 167°F)</li> <li>• Xeon® E3-1268L v5 : -40°C to 70°C (-40°F to 158°F)</li> </ul> <b>65W TDP CPU :</b> <ul style="list-style-type: none"> <li>• Core™ i7, i5, i3 : -40°C to 55°C (-40°F to 131°F)</li> </ul> <b>80W TDP CPU :</b> <ul style="list-style-type: none"> <li>• Xeon® E3-1275 v6, E3-1275 v5, E3-1225 v5 : -40°C to 45°C (-40°F to 113°F)</li> </ul>
Storage Temperature	-40°C to 85°C (-40°F to 185°F)
Humidity	5% to 95% Humidity, non-condensing
Relative Humidity	95% at 75°C
Shock	<ul style="list-style-type: none"> <li>• IEC 60068-2-27</li> <li>• SSD : 50G @ Wallmount, Half-sine, 11ms</li> </ul>
Vibration	<ul style="list-style-type: none"> <li>• IEC 60068-2-64</li> <li>• SSD : 5Grms, 5Hz to 500Hz, 3 Axis</li> </ul>
EMC	CE, FCC, EN50155, EN50121-3-2

### 1.3.3 Specifications of ECS-9201M

<b>System</b>	
Processor	Quad Core 7th/6th Intel® Xeon®/Core™ i7/i5/i3 Processor (Kaby Lake-S/Skylake-S)
Chipset	Intel® C236
BIOS	AMI
SIO	IT8786E
Memory	<ul style="list-style-type: none"> <li>• DDR4 2400/2133 MHz</li> <li>• Up to 64GB</li> <li>• 2 260-pin SO-DIMM Socket</li> </ul>
<b>I/O Interface</b>	
Serial	4 COM RS-232/422/485 with auto flow control (ESD 8KV)
USB	<ul style="list-style-type: none"> <li>• 8 External USB 3.0 (4 Front, 4 Rear)</li> <li>• 1 USB 2.0 (Internal)</li> </ul>
Isolated DIO	32 Isolated DIO (16 DI, 16 DO)
LED	Power, HDD, Wireless, PoE
SIM Card	3 External SIM Card Socket
<b>Expansion</b>	
Mini PCIe	3 Full-size for PCIe/USB/External SIM Card/mSATA
PCI/PCIe	1 PCI Slot
M.2	1 M.2 Socket (Key ID : M)
<b>Graphics</b>	
Graphics Processor	Intel® HD Graphics P630/630/P530/530
Interface	<ul style="list-style-type: none"> <li>• DVI-I : Up to 1920 x 1200 @ 60Hz</li> <li>• DVI-D : Up to 1920 x 1200 @ 60Hz</li> <li>• DisplayPort : Up to 4096 x 2304 @ 60Hz</li> </ul>
<b>Storage</b>	
SATA	2 SATA III (6Gbps) support software RAID 0, 1
mSATA	3 SATA III (Mini PCIe Type, 6Gbps)
Storage Device	<ul style="list-style-type: none"> <li>• 1 CFast Socket, Push-in/Push-out Ejector</li> <li>• 2 Front-access 2.5" SSD/HDD Tray</li> </ul>
<b>Audio</b>	
Audio Codec	Realtek ALC888S-VD, 7.1 Channel HD Audio
Audio Interface	1 Mic-in, 1 Line-out
<b>Ethernet</b>	
LAN 1	Intel® I219LM GigE LAN supports iAMT 11.0
LAN 2	Intel® I210 GigE LAN

<b>PoE (M12)</b>	
LAN 3	GigE IEEE 802.3at (25.5W/48V) PoE <sup>+</sup> by Intel® I210, M12 Connector
LAN 4	GigE IEEE 802.3at (25.5W/48V) PoE <sup>+</sup> by Intel® I210, M12 Connector
LAN 5	GigE IEEE 802.3at (25.5W/48V) PoE <sup>+</sup> by Intel® I210, M12 Connector
LAN 6	GigE IEEE 802.3at (25.5W/48V) PoE <sup>+</sup> by Intel® I210, M12 Connector
<b>Power</b>	
Input Voltage	6V to 36V, DC-in
Power Interface	3-pin Terminal Block : V+, V-, Frame Ground
Ignition Control	16 Mode (Internal)
Remote Switch	3-pin Terminal Block : On, Off, IGN
Surge Protection	Up to 80V/1ms Transient Power
<b>Others</b>	
TPM	Optional Infineon SLB9665 supports TPM 2.0, LPC interface
Watchdog Timer	Reset : 1 to 255 sec./min. per step
Smart Management	Wake on LAN, PXE supported
HW Monitor	Monitoring temperature, voltages. Auto throttling control when CPU overheats.
<b>Software Support</b>	
OS	Windows 10, Windows 8.1, Windows 7, Linux
<b>Mechanical</b>	
Dimensions (WxDxH)	260mm x 215mm x 79mm (10.2" x 8.5" x 3.1")
Weight	4.2 kg (9.26 lb)
Mounting	<ul style="list-style-type: none"> <li>• Wallmount by mounting bracket</li> <li>• DIN Rail Mount (Optional)</li> <li>• 2U Rackmount (Optional)</li> </ul>
<b>Environment</b>	
Operating Temperature	<b>35W TDP CPU :</b> <ul style="list-style-type: none"> <li>• Core™ i7, i5, i3 : -40°C to 75°C (-40°F to 167°F)</li> <li>• Xeon® E3-1268L v5 : -40°C to 70°C (-40°F to 158°F)</li> </ul> <b>65W TDP CPU :</b> <ul style="list-style-type: none"> <li>• Core™ i7, i5, i3 : -40°C to 55°C (-40°F to 131°F)</li> </ul> <b>80W TDP CPU :</b> <ul style="list-style-type: none"> <li>• Xeon® E3-1275 v6, E3-1275 v5, E3-1225 v5 : -40°C to 45°C (-40°F to 113°F)</li> </ul>

Storage Temperature	-40°C to 85°C (-40°F to 185°F)
Humidity	5% to 95% Humidity, non-condensing
Relative Humidity	95% at 75°C
Shock	<ul style="list-style-type: none"> <li>• IEC 60068-2-27</li> <li>• SSD : 50G @ Wallmount, Half-sine, 11ms</li> </ul>
Vibration	<ul style="list-style-type: none"> <li>• IEC 60068-2-64</li> <li>• SSD : 5Grms, 5Hz to 500Hz, 3 Axis</li> </ul>
EMC	CE, FCC, EN50155, EN50121-3-2

### 1.3.4 Specifications of ECS-9201

<b>System</b>	
Processor	Quad Core 7th/6th Intel® Xeon®/Core™ i7/i5/i3 Processor (Kaby Lake-S/Skylake-S)
Chipset	Intel® C236
BIOS	AMI
SIO	IT8786E
Memory	<ul style="list-style-type: none"> <li>• DDR4 2400/2133 MHz</li> <li>• Up to 64GB</li> <li>• 2 260-pin SO-DIMM Socket</li> </ul>
<b>I/O Interface</b>	
Serial	4 COM RS-232/422/485 with auto flow control (ESD 8KV)
USB	<ul style="list-style-type: none"> <li>• 8 External USB 3.0 (4 Front, 4 Rear)</li> <li>• 1 USB 2.0 (Internal)</li> </ul>
Isolated DIO	32 Isolated DIO (16 DI, 16 DO)
LED	Power, HDD, Wireless, PoE
SIM Card	3 External SIM Card Socket
<b>Expansion</b>	
Mini PCIe	3 Full-size for PCIe/USB/External SIM Card/mSATA
PCI/PCIe	1 PCI Slot
M.2	1 M.2 Socket (Key ID : M)
<b>Graphics</b>	
Graphics Processor	Intel® HD Graphics P630/630/P530/530
Interface	<ul style="list-style-type: none"> <li>• DVI-I : Up to 1920 x 1200 @ 60Hz</li> <li>• DVI-D : Up to 1920 x 1200 @ 60Hz</li> <li>• DisplayPort : Up to 4096 x 2304 @ 60Hz</li> </ul>



<b>Storage</b>	
SATA	2 SATA III (6Gbps) support software RAID 0, 1
mSATA	3 SATA III (Mini PCIe Type, 6Gbps)
Storage Device	<ul style="list-style-type: none"> <li>• 1 CFast Socket, Push-in/Push-out Ejector</li> <li>• 2 Front-access 2.5" SSD/HDD Tray</li> </ul>
<b>Audio</b>	
Audio Codec	Realtek ALC888S-VD, 7.1 Channel HD Audio
Audio Interface	1 Mic-in, 1 Line-out
<b>Ethernet</b>	
LAN 1	Intel® I219LM GigE LAN supports iAMT 11.0
LAN 2	Intel® I210 GigE LAN
<b>PoE</b>	
LAN 3	GigE IEEE 802.3at (25.5W/48V) PoE <sup>+</sup> by Intel® I210
LAN 4	GigE IEEE 802.3at (25.5W/48V) PoE <sup>+</sup> by Intel® I210
LAN 5	GigE IEEE 802.3at (25.5W/48V) PoE <sup>+</sup> by Intel® I210
LAN 6	GigE IEEE 802.3at (25.5W/48V) PoE <sup>+</sup> by Intel® I210
<b>Power</b>	
Input Voltage	6V to 36V, DC-in
Power Interface	3-pin Terminal Block : V+, V-, Frame Ground
Ignition Control	16 Mode (Internal)
Remote Switch	3-pin Terminal Block : On, Off, IGN
Surge Protection	Up to 80V/1ms Transient Power
<b>Others</b>	
TPM	Optional Infineon SLB9665 supports TPM 2.0, LPC interface
Watchdog Timer	Reset : 1 to 255 sec./min. per step
Smart Management	Wake on LAN, PXE supported
HW Monitor	Monitoring temperature, voltages. Auto throttling control when CPU overheats.
<b>Software Support</b>	
OS	Windows 10, Windows 8.1, Windows 7, Linux
<b>Mechanical</b>	
Dimensions (WxDxH)	260mm x 215mm x 79mm (10.2" x 8.5" x 3.1")
Weight	4.2 kg (9.26 lb)
Mounting	<ul style="list-style-type: none"> <li>• Wallmount by mounting bracket</li> <li>• DIN Rail Mount (Optional)</li> <li>• 2U Rackmount (Optional)</li> </ul>

Environment	
Operating Temperature	<b>35W TDP CPU :</b> <ul style="list-style-type: none"> <li>• Core™ i7, i5, i3 : -40°C to 75°C (-40°F to 167°F)</li> <li>• Xeon® E3-1268L v5 : -40°C to 70°C (-40°F to 158°F)</li> </ul> <b>65W TDP CPU :</b> <ul style="list-style-type: none"> <li>• Core™ i7, i5, i3 : -40°C to 55°C (-40°F to 131°F)</li> </ul> <b>80W TDP CPU :</b> <ul style="list-style-type: none"> <li>• Xeon® E3-1275 v6, E3-1275 v5, E3-1225 v5 : -40°C to 45°C (-40°F to 113°F)</li> </ul>
Storage Temperature	-40°C to 85°C (-40°F to 185°F)
Humidity	5% to 95% Humidity, non-condensing
Relative Humidity	95% at 75°C
Shock	<ul style="list-style-type: none"> <li>• IEC 60068-2-27</li> <li>• SSD : 50G @ Wallmount, Half-sine, 11ms</li> </ul>
Vibration	<ul style="list-style-type: none"> <li>• IEC 60068-2-64</li> <li>• SSD : 5Grms, 5Hz to 500Hz, 3 Axis</li> </ul>
EMC	CE, FCC, EN50155, EN50121-3-2

### 1.3.5 Specifications of ECS-9110

<b>System</b>	
Processor	Quad Core 7th/6th Intel® Xeon®/Core™ i7/i5/i3 Processor (Kaby Lake-S/Skylake-S)
Chipset	Intel® C236
BIOS	AMI
SIO	IT8786E
Memory	<ul style="list-style-type: none"> <li>• DDR4 2400/2133 MHz</li> <li>• Up to 64GB</li> <li>• 2 260-pin SO-DIMM Socket</li> </ul>
<b>I/O Interface</b>	
Serial	4 COM RS-232/422/485 with auto flow control (ESD 8KV)
USB	<ul style="list-style-type: none"> <li>• 8 External USB 3.0 (4 Front, 4 Rear)</li> <li>• 1 USB 2.0 (Internal)</li> </ul>
Isolated DIO	32 Isolated DIO (16 DI, 16 DO)
LED	Power, HDD, Wireless
SIM Card	3 External SIM Card Socket
<b>Expansion</b>	
Mini PCIe	3 Full-size for PCIe/USB/External SIM Card/mSATA
PCI/PCIe	1 PCIe x16 Slot supports up to 160W Power Budget
M.2	1 M.2 Socket (Key ID : M)
<b>Graphics</b>	
Graphics Processor	Intel® HD Graphics P630/630/P530/530
Interface	<ul style="list-style-type: none"> <li>• DVI-I : Up to 1920 x 1200 @ 60Hz</li> <li>• DVI-D : Up to 1920 x 1200 @ 60Hz</li> <li>• DisplayPort : Up to 4096 x 2304 @ 60Hz</li> </ul>
<b>Storage</b>	
SATA	2 SATA III (6Gbps) support software RAID 0, 1
mSATA	3 SATA III (Mini PCIe Type, 6Gbps)
Storage Device	<ul style="list-style-type: none"> <li>• 1 CFast Socket, Push-in/Push-out Ejector</li> <li>• 2 Front-access 2.5" SSD/HDD Tray</li> </ul>
<b>Audio</b>	
Audio Codec	Realtek ALC888S-VD, 7.1 Channel HD Audio
Audio Interface	1 Mic-in, 1 Line-out
<b>Ethernet</b>	
LAN 1	Intel® I219LM GigE LAN supports iAMT 11.0
LAN 2	Intel® I210 GigE LAN

<b>Power</b>	
Input Voltage	6V to 36V, DC-in
Power Interface	3-pin Terminal Block : V+, V-, Frame Ground
Ignition Control	16 Mode (Internal)
Remote Switch	3-pin Terminal Block : On, Off, IGN
Surge Protection	Up to 80V/1ms Transient Power
<b>Others</b>	
TPM	Optional Infineon SLB9665 supports TPM 2.0, LPC interface
Watchdog Timer	Reset : 1 to 255 sec./min. per step
Smart Management	Wake on LAN, PXE supported
HW Monitor	Monitoring temperature, voltages. Auto throttling control when CPU overheats.
<b>Software Support</b>	
OS	Windows 10, Windows 8.1, Windows 7, Linux
<b>Mechanical</b>	
Dimensions (WxDxH)	260mm x 215mm x 79mm (10.2" x 8.5" x 3.1")
Weight	4.2 kg (9.26 lb)
Mounting	<ul style="list-style-type: none"> <li>• Wallmount by mounting bracket</li> <li>• DIN Rail Mount (Optional)</li> <li>• 2U Rackmount (Optional)</li> </ul>
<b>Environment</b>	
Operating Temperature	<b>35W TDP CPU :</b> <ul style="list-style-type: none"> <li>• Core™ i7, i5, i3 : -40°C to 75°C (-40°F to 167°F)</li> <li>• Xeon® E3-1268L v5 : -40°C to 70°C (-40°F to 158°F)</li> </ul> <b>65W TDP CPU :</b> <ul style="list-style-type: none"> <li>• Core™ i7, i5, i3 : -40°C to 55°C (-40°F to 131°F)</li> </ul> <b>80W TDP CPU :</b> <ul style="list-style-type: none"> <li>• Xeon® E3-1275 v6, E3-1275 v5, E3-1225 v5 : -40°C to 45°C (-40°F to 113°F)</li> </ul>
Storage Temperature	-40°C to 85°C (-40°F to 185°F)
Humidity	5% to 95% Humidity, non-condensing
Relative Humidity	95% at 75°C
Shock	<ul style="list-style-type: none"> <li>• IEC 60068-2-27</li> <li>• SSD : 50G @ Wallmount, Half-sine, 11ms</li> </ul>
Vibration	<ul style="list-style-type: none"> <li>• IEC 60068-2-64</li> <li>• SSD : 5Grms, 5Hz to 500Hz, 3 Axis</li> </ul>
EMC	CE, FCC, EN50155, EN50121-3-2

### 1.3.6 Specifications of ECS-9101

<b>System</b>	
Processor	Quad Core 7th/6th Intel® Xeon®/Core™ i7/i5/i3 Processor (Kaby Lake-S/Skylake-S)
Chipset	Intel® C236
BIOS	AMI
SIO	IT8786E
Memory	<ul style="list-style-type: none"> <li>• DDR4 2400/2133 MHz</li> <li>• Up to 64GB</li> <li>• 2 260-pin SO-DIMM Socket</li> </ul>
<b>I/O Interface</b>	
Serial	4 COM RS-232/422/485 with auto flow control (ESD 8KV)
USB	<ul style="list-style-type: none"> <li>• 8 External USB 3.0 (4 Front, 4 Rear)</li> <li>• 1 USB 2.0 (Internal)</li> </ul>
Isolated DIO	32 Isolated DIO (16 DI, 16 DO)
LED	Power, HDD, Wireless
SIM Card	3 External SIM Card Socket
<b>Expansion</b>	
Mini PCIe	3 Full-size for PCIe/USB/External SIM Card/mSATA
PCI/PCIe	1 PCI Slot
M.2	1 M.2 Socket (Key ID : M)
<b>Graphics</b>	
Graphics Processor	Intel® HD Graphics P630/630/P530/530
Interface	<ul style="list-style-type: none"> <li>• DVI-I : Up to 1920 x 1200 @ 60Hz</li> <li>• DVI-D : Up to 1920 x 1200 @ 60Hz</li> <li>• DisplayPort : Up to 4096 x 2304 @ 60Hz</li> </ul>
<b>Storage</b>	
SATA	2 SATA III (6Gbps) support software RAID 0, 1
mSATA	3 SATA III (Mini PCIe Type, 6Gbps)
Storage Device	<ul style="list-style-type: none"> <li>• 1 CFast Socket, Push-in/Push-out Ejector</li> <li>• 2 Front-access 2.5" SSD/HDD Tray</li> </ul>
<b>Audio</b>	
Audio Codec	Realtek ALC888S-VD, 7.1 Channel HD Audio
Audio Interface	1 Mic-in, 1 Line-out
<b>Ethernet</b>	
LAN 1	Intel® I219LM GigE LAN supports iAMT 11.0
LAN 2	Intel® I210 GigE LAN

<b>Power</b>	
Input Voltage	6V to 36V, DC-in
Power Interface	3-pin Terminal Block : V+, V-, Frame Ground
Ignition Control	16 Mode (Internal)
Remote Switch	3-pin Terminal Block : On, Off, IGN
Surge Protection	Up to 80V/1ms Transient Power
<b>Others</b>	
TPM	Optional Infineon SLB9665 supports TPM 2.0, LPC interface
Watchdog Timer	Reset : 1 to 255 sec./min. per step
Smart Management	Wake on LAN, PXE supported
HW Monitor	Monitoring temperature, voltages. Auto throttling control when CPU overheats.
<b>Software Support</b>	
OS	Windows 10, Windows 8.1, Windows 7, Linux
<b>Mechanical</b>	
Dimensions (WxDxH)	260mm x 215mm x 79mm (10.2" x 8.5" x 3.1")
Weight	4.2 kg (9.26 lb)
Mounting	<ul style="list-style-type: none"> <li>• Wallmount by mounting bracket</li> <li>• DIN Rail Mount (Optional)</li> <li>• 2U Rackmount (Optional)</li> </ul>
<b>Environment</b>	
Operating Temperature	<b>35W TDP CPU :</b> <ul style="list-style-type: none"> <li>• Core™ i7, i5, i3 : -40°C to 75°C (-40°F to 167°F)</li> <li>• Xeon® E3-1268L v5 : -40°C to 70°C (-40°F to 158°F)</li> </ul> <b>65W TDP CPU :</b> <ul style="list-style-type: none"> <li>• Core™ i7, i5, i3 : -40°C to 55°C (-40°F to 131°F)</li> </ul> <b>80W TDP CPU :</b> <ul style="list-style-type: none"> <li>• Xeon® E3-1275 v6, E3-1275 v5, E3-1225 v5 : -40°C to 45°C (-40°F to 113°F)</li> </ul>
Storage Temperature	-40°C to 85°C (-40°F to 185°F)
Humidity	5% to 95% Humidity, non-condensing
Relative Humidity	95% at 75°C
Shock	<ul style="list-style-type: none"> <li>• IEC 60068-2-27</li> <li>• SSD : 50G @ Wallmount, Half-sine, 11ms</li> </ul>
Vibration	<ul style="list-style-type: none"> <li>• IEC 60068-2-64</li> <li>• SSD : 5Grms, 5Hz to 500Hz, 3 Axis</li> </ul>
EMC	CE, FCC, EN50155, EN50121-3-2

## 1.4 Supported CPU List

Processor No.	TDP	Cache	Max. Frequency	Embedded
Intel® Xeon® E3-1275 v6	80W	8M	Up to 4.20 GHz	Y
Intel® Xeon® E3-1275 v5	80W	8M	Up to 4.00 GHz	Y
Intel® Xeon® E3-1225 v5	80W	8M	Up to 3.70 GHz	Y
Intel® Xeon® E3-1268 v5	35W	8M	Up to 3.40 GHz	Y
Intel® Core™ i7-7700	65W	8M	Up to 4.20 GHz	Y
Intel® Core™ i7-7700T	35W	8M	Up to 3.80 GHz	Y
Intel® Core™ i7-6700	65W	8M	Up to 4.00 GHz	Y
Intel® Core™ i7-6700TE	35W	8M	Up to 3.40 GHz	Y
Intel® Core™ i5-7500	65W	6M	Up to 3.80 GHz	Y
Intel® Core™ i5-7500T	35W	6M	Up to 3.30 GHz	Y
Intel® Core™ i5-6500	65W	6M	Up to 3.60 GHz	Y
Intel® Core™ i5-6500TE	35W	6M	Up to 3.30 GHz	Y
Intel® Core™ i3-7101E	65W	3M	Up to 3.90 GHz	Y
Intel® Core™ i3-7101TE	35W	3M	Up to 3.40 GHz	Y
Intel® Core™ i3-6100	65W	4M	Up to 3.70 GHz	Y
Intel® Core™ i3-6100TE	35W	4M	Up to 2.70 GHz	Y

# 1.5 Mechanical Dimension

## 1.5.1 Dimensions of ECS-9210M

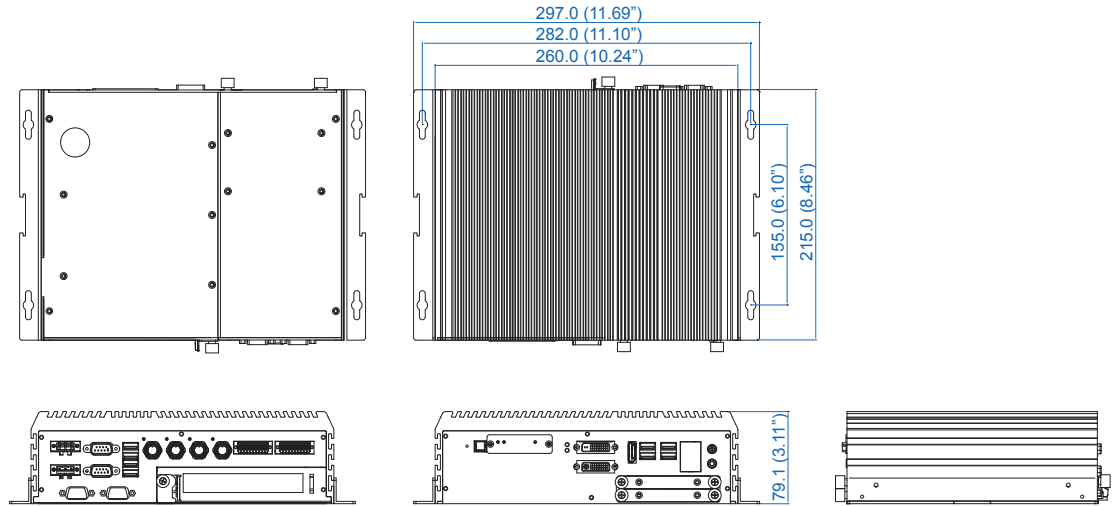

Unit: mm (inch)

## 1.5.2 Dimensions of ECS-9210

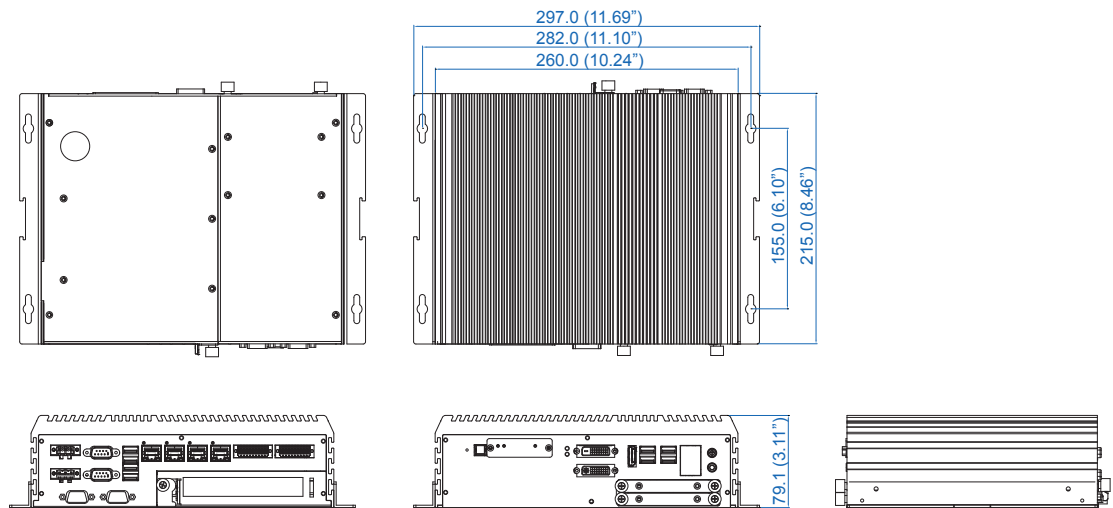

Unit: mm (inch)



### 1.5.3 Dimensions of ECS-9201M

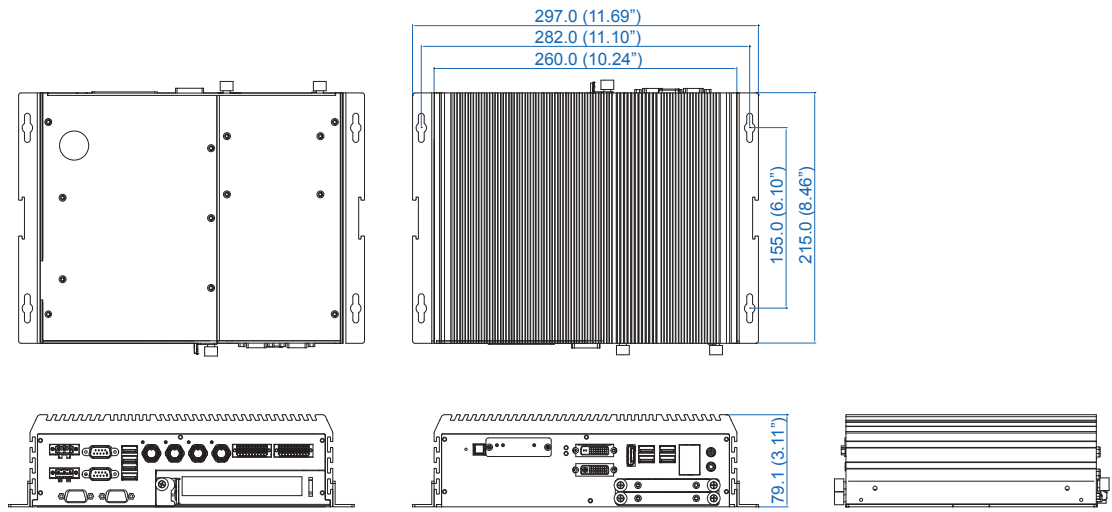

Unit: mm (inch)

### 1.5.4 Dimensions of ECS-9201

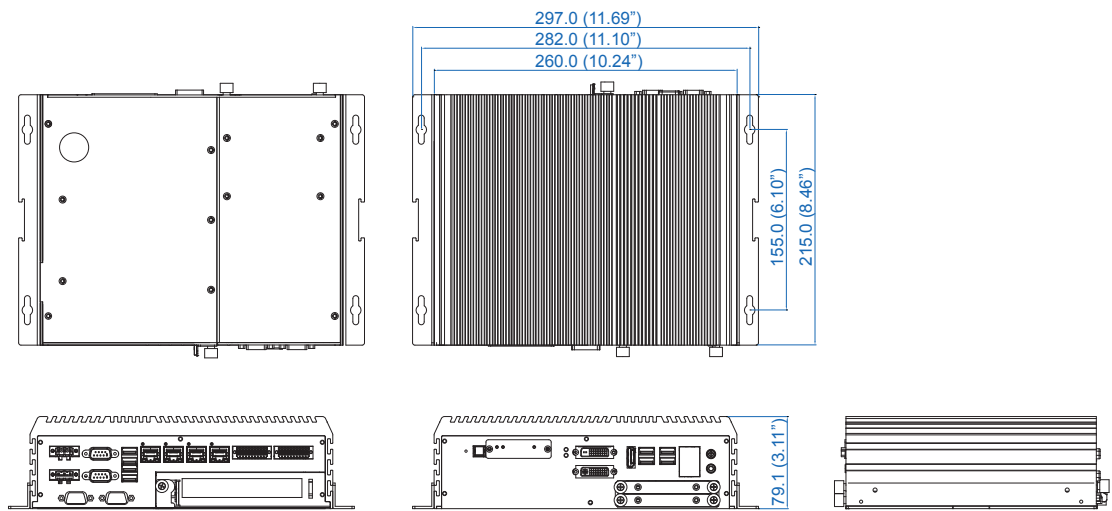

Unit: mm (inch)

### 1.5.5 Dimensions of ECS-9110

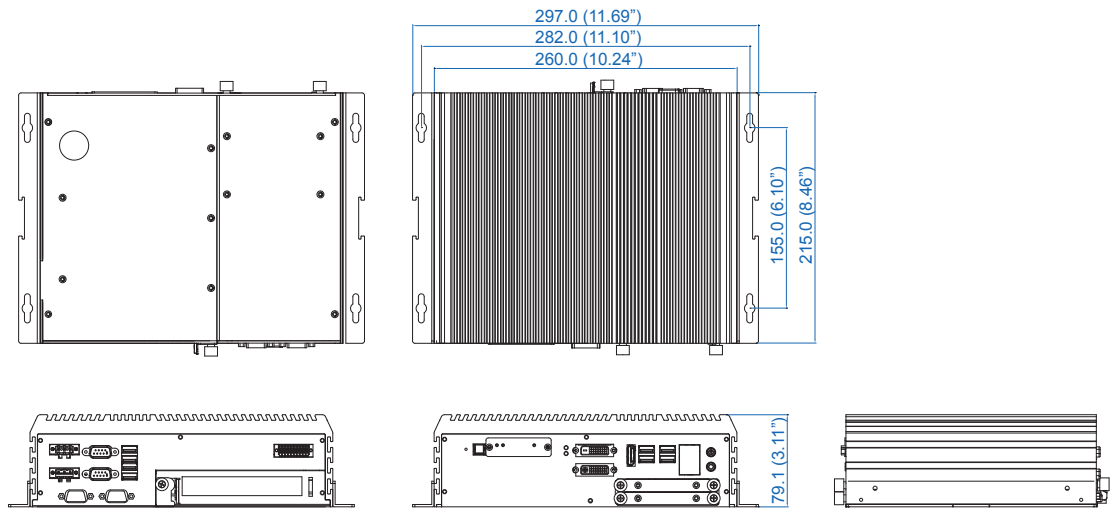

Unit: mm (inch)

### 1.5.6 Dimensions of ECS-9101

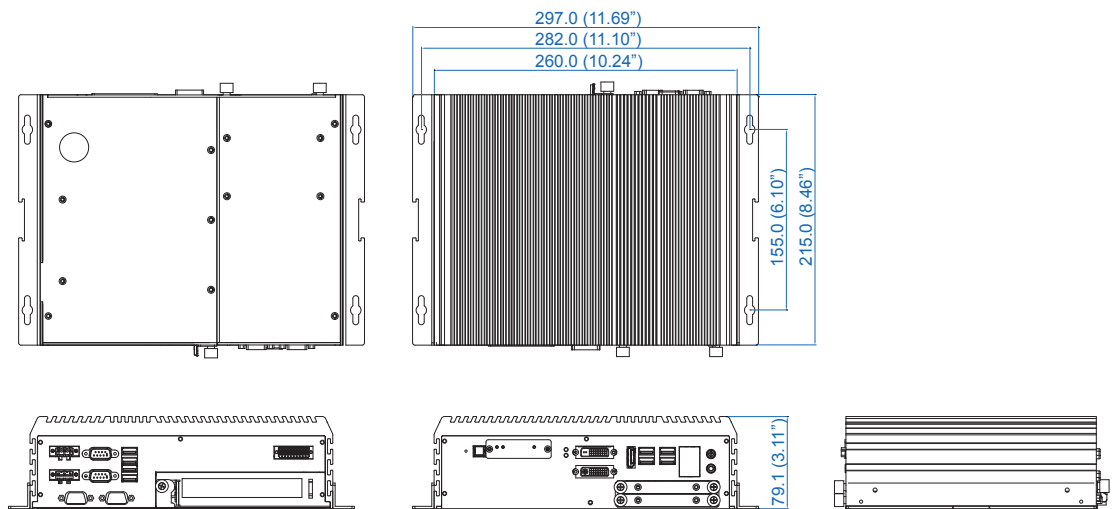

Unit: mm (inch)

# 2

## GETTING TO KNOW YOUR ECS-9200/9100

### 2.1 Packing List

Item	Description	Qty
1	ECS-9200/9100 Expandable Fanless Embedded System (According to the configuration you order, the ECS-9200/9100 series may contain SSD/HDD and DDR4 SO-DIMM. Please verify these items if necessary.)	1
2	ECS-9200-Accessory box, which contains <ul style="list-style-type: none"><li>• Wall-mounting bracket</li><li>• KHS#6-32x6 screw for wall-mounting bracket</li><li>• M2.5x6 screw for Mini PCIe Slot</li><li>• Din-Rail-PH-M4x16.5-S Ni</li><li>• PH-M3x6 screw for M.2 slot</li><li>• M3x11 Spring screws for CPU</li><li>• 3-pin pluggable terminal block</li><li>• 20-pin pluggable terminal block</li><li>• Foot Pad</li><li>• F-M3x4 for SSD/HDD screws</li></ul>	2 4 3 4 1 4 2 2 4 4
3	ECS-9100-Accessory box, which contains <ul style="list-style-type: none"><li>• Wall-mounting bracket</li><li>• KHS#6-32x6 screw for wall-mounting bracket</li><li>• M2.5x6 screw for Mini PCIe Slot</li><li>• Din-Rail-PH-M4x16.5-S Ni</li><li>• PH-M3x6 screw for M.2 slot</li><li>• M3x11 Spring screws for CPU</li><li>• 3-pin pluggable terminal block</li><li>• 20-pin pluggable terminal block</li><li>• Foot Pad</li><li>• F-M3x4 for SSD/HDD screws</li></ul>	2 4 3 4 1 4 2 1 4 4

## 2.2 Front Panel I/O & Functions

In Vecow ECS-9200/9100 series family, all I/O connectors are located on front panel and rear panel. Most of the general connections to computer device, such as USB, LAN Jack, Audio, Display Port, DVI-I, DVI-D and any additional storage, are placed on the front panel.

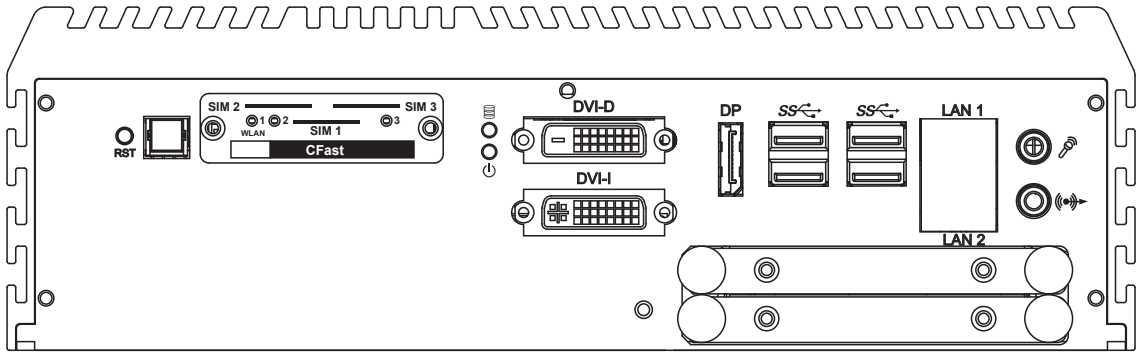

### 2.2.1 Power Button

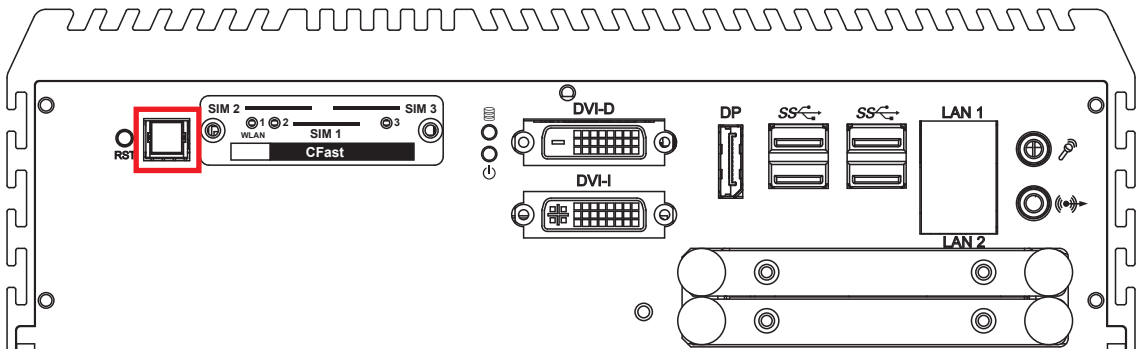

The Power Button is a non-latched switch with dual color LED indication. It indicates power status: S0, S3 and S5. More detail LED indications are listed as follows:

LED Color	Power Status	System Status
Solid Blue	S0	System working
Solid Orange	S3, S5	Suspend to RAM, System off with standby power

To power on the system, press the power button and then the blue LED is lightened. To power off the system, you can either command shutdown by OS operation, or just simply press the power button.

If system error, you can just press the power button for 4 seconds to shut down the machine directly. Please do note that a 4-second interval between each 2 power-on/ power-off operation is necessary in normal working status. (For example, once turning off the system, you have to wait for 4 seconds to initiate another power-on operation.)

## 2.2.2 Reset Tact Switch

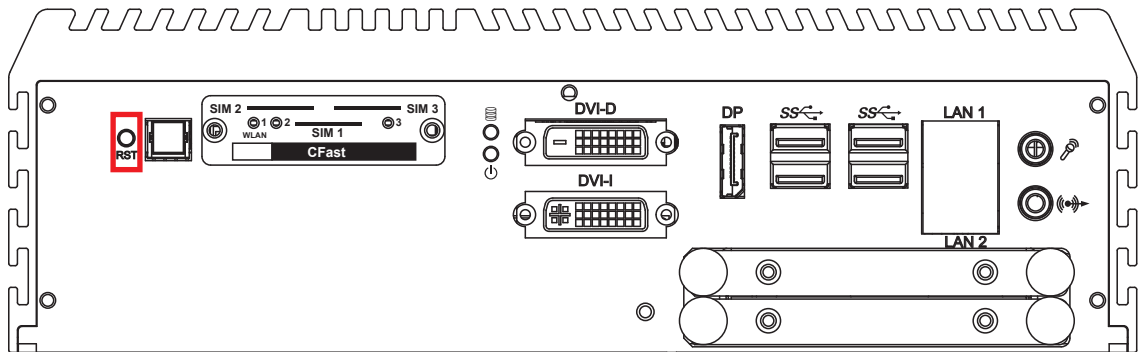

It is a hardware reset switch. Use this switch to reset the system without power off the system. Press the Reset Switch for a few seconds, and then reset will be enabled.

## 2.2.3 CFast Card

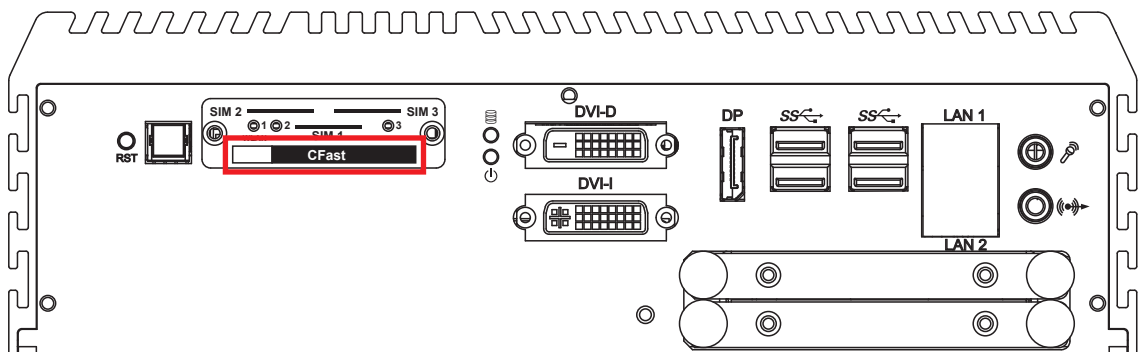

There is a CFast socket on the front panel supporting Type-I/II Compact Flash card. It is implemented by a SATA III Port from C236 PCH. Be sure to disconnect the power source and unscrew the CFast socket cover before installing a CFast card. The ECS-9200/9100 does not support the CFast hot swap and PnP (Plug and Play) functions. It is necessary remove power source first before inserting or removing the CFast card.

The pinouts of CFast port are listed as follows:

Pin No.	Description	Pin No.	Description
S1	GND	PC6	NC
S2	SATA_TXP4	PC7	GND
S3	SATA_TXN4	PC8	CFAST_LED
S4	GND	PC9	NC
S5	SATA_RXN4	PC10	NC
S6	SATA_RXP4	PC11	NC
S7	GND	PC12	NC

Pin No.	Description	Pin No.	Description
PC1	GND	PC13	+3.3V
PC2	GND	PC14	+3.3V
PC3	NC	PC15	GND
PC4	NC	PC16	GND
PC5	NC	PC17	NC

## 2.2.4 PWR and HDD LED Indicator

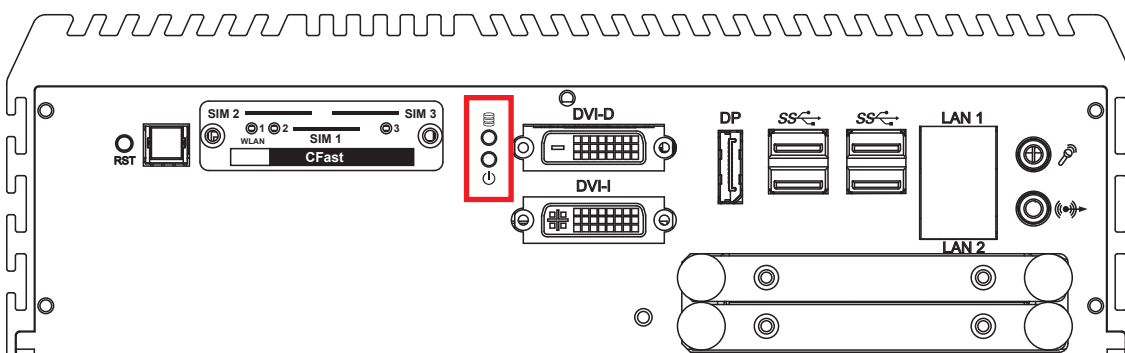

**HDD LED/Yellow :** A Hard Disk/CFast LED. If the LED is on, it indicates that the system's storage is functional. If it is off, it indicates that the system's storage is not functional. If it is flashing, it indicates data access activities.

**Power LED/Green:** If the LED is solid green, it indicates that the system is powered on.

LED Color	Power Status	System Status
Yellow	HDD/CFast	<ul style="list-style-type: none"> <li>• On/ Off : Storage status, function or not.</li> <li>• Twinkling : Data transferring.</li> </ul>
Green	Power	System power status (On/Off)

## 2.2.5 DVI-D Connector

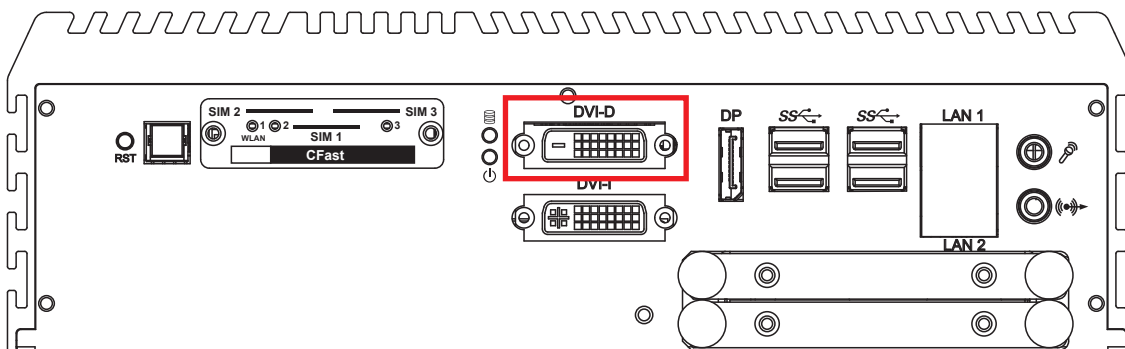

The DVI-D connector on the front panel supports DVI display. This connector can output DVI signal. The DVI output mode supports up to 1920 x 1200 resolution and output mode supports up to 1920 x 1200 resolution. The DVI is automatically selected according to the connected display. You will need a DVI-D cable when connecting to a display device.

## 2.2.6 DVI-I Connector

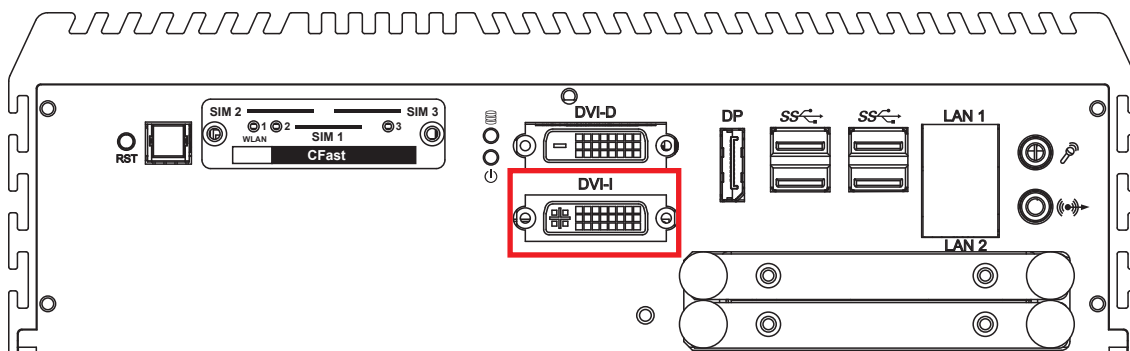

The DVI-I connector on the front panel supports both DVI and VGA display modes. This connector can output DVI signals. The DVI output mode supports up to 1920x1200 resolution. The DVI mode is automatically selected according to the connected display and you will need a DVI-I cable when connecting to a display device. The VGA output mode supports up to 1920x1200 resolution. If using VGA function, you will need a DVI-I to VGA module connected to DVI-I device. Below is the DVI-I to VGA dongle image :



## 2.2.7 DisplayPort

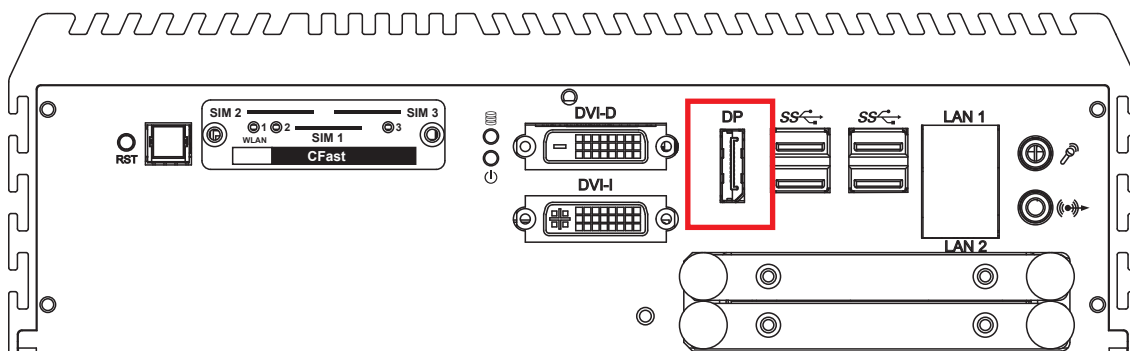

Onboard Display Port supports auxiliary channel dual mode and the connection supports up to 4096x2304 resolution at 60 Hz.

Multi-Stream Transport Display Resolutions Table:

Multi-Stream Transport Display	Max. Resolution
One panel Display	4096x2304@60Hz
Two panel Displays concurrently	2880x1800@60Hz
Three panel Displays concurrently	2304x1440@60Hz

## 2.2.8 USB 3.0

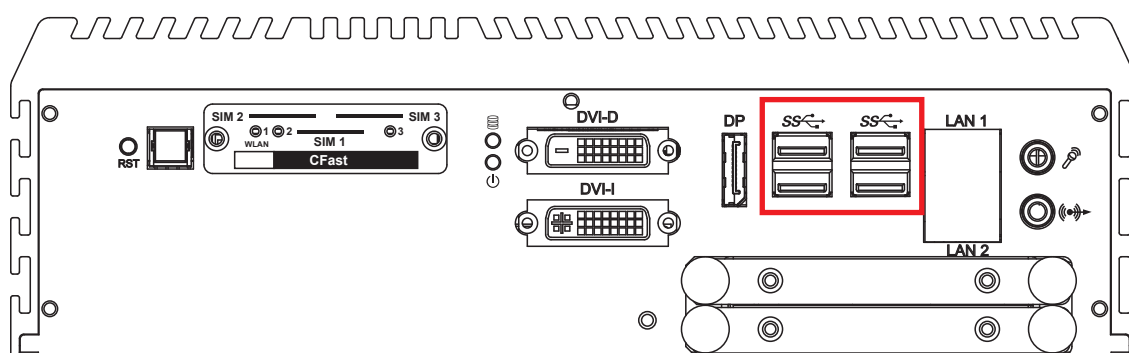

There are 4 USB 3.0 connections available supporting up to 5GB per second data rate in the front side of ECS-9200/9100. It is also compliant with the requirements of Super Speed (SS), High Speed (HS), Full Speed (FS) and Low Speed (LS).

## 2.2.9 Ethernet Port

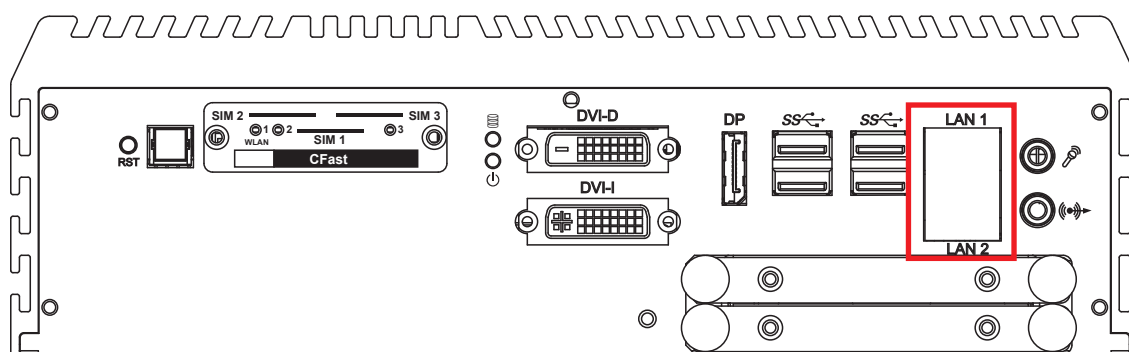

There are dual 8-pin RJ-45 jacks supporting 10/100/1000 Mbps Ethernet connections in the front side. LAN 1 is powered by Intel i219 Ethernet Phy and LAN 2 is powered by Intel I210 Ethernet engine. When both LAN 1 and LAN 2 work at normal status, iAMT 11.0 function is enabled.

Using suitable RJ-45 cable, you can connect the system to a computer or to any other devices with Ethernet connection; for example, a hub or a switch. Moreover, both LAN 1 and LAN 2 support Wake on LAN and Pre-boot functions. The pin-outs of LAN 1 and LAN 2 are listed as follows:



Pin No.	10/100 Mbps	1000Mbps
1	E_TX+	MDI0_P
2	E_TX-	MDI0_N
3	E_RX+	MDI1_P
4	----	MDI2_P
5	-----	MDI2_N
6	E_RX-	MDI1_N
7	----	MDI3_P
8	-----	MDI3_N

Each LAN port is supported by standard RJ-45 connector with LED indicators to present Active/Link/Speed status of the connection.

The LED indicator on the right bottom corner lightens in solid green when the cable is properly connected to a 100 Mbps Ethernet network, and it lightens in solid orange when the cable is properly connected to a 1000Mbps Ethernet network. The left LED will keep twinkling/ off when Ethernet data packets are being transmitted/ received.

	10Mbps	100Mbps	1000Mbps
Right Bottom Led	Off	Solid Green	Solid Orange
Left Bottom Led	Flash Yellow	Flash Yellow	Flash Yellow

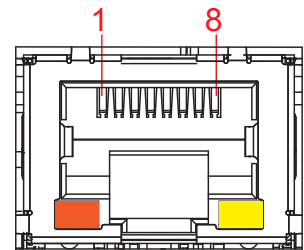

## 2.2.10 Audio Jack

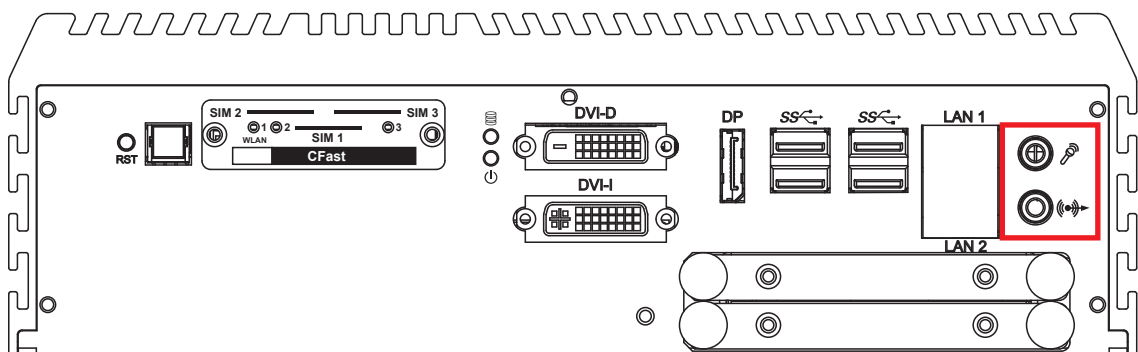

There are 2 audio connectors, Mic-in and Line-out, in the front side of ECS-9200. Onboard Realtek ALC888S-VD audio codec supports 7.1 channel HD audio and fully complies with Intel® High Definition Audio (Azalia) specifications.

To utilize the audio function in Windows platform, you need to install corresponding drivers for both Intel C236 chipset and Realtek ALC888S-VD codec.

## 2.2.11 WLAN LED, Mini PCIe, SIM Card Comparison

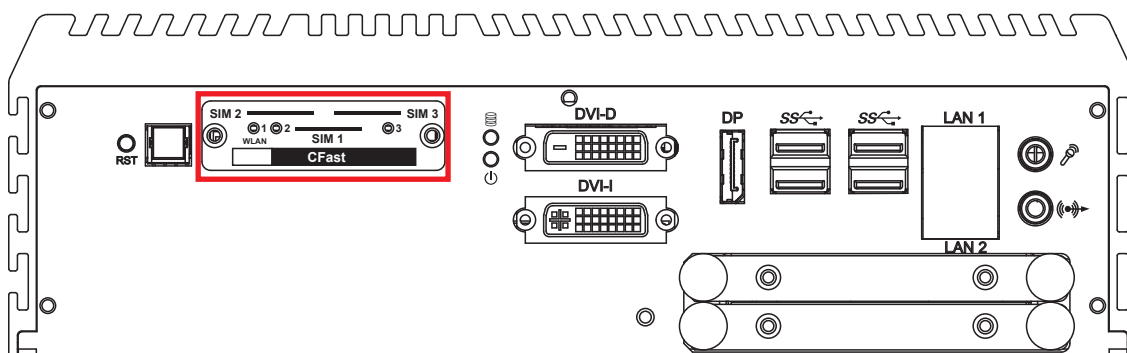

Mini PCIe Slot/SIM Slot/WLAN LED Mapping Table :

Mini PCIe	SIM	LED
Mini PCIe 1	SIM 1 (CN12)	1
Mini PCIe 2	SIM 2 (CN13)	2
Mini PCIe 3	SIM 3 (CN11)	3

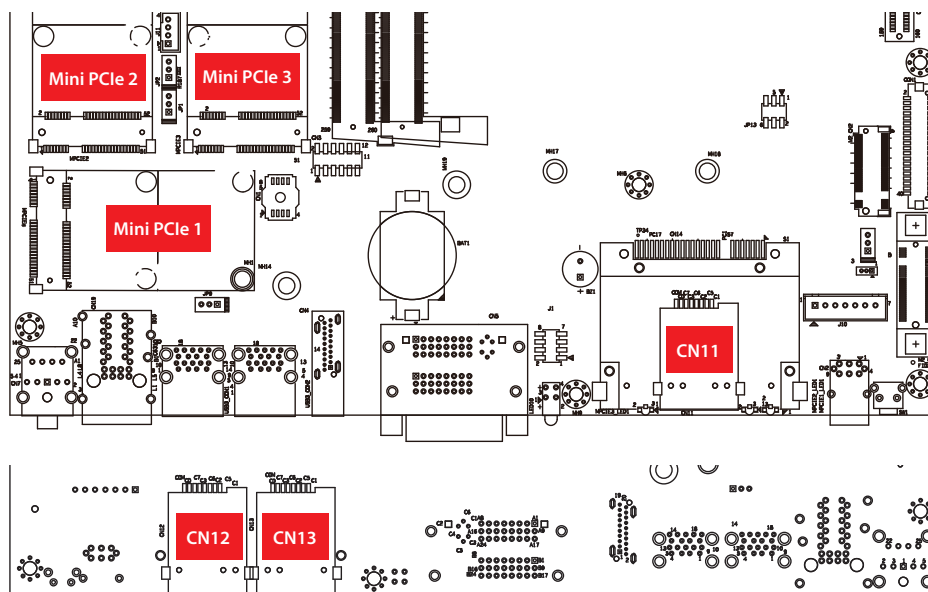

### Note:

The SIM card sockets do not support hot-plug. Please make sure to unplug the system power before inserting the SIM card(s).

## 2.2.12 SSD/HDD Tray

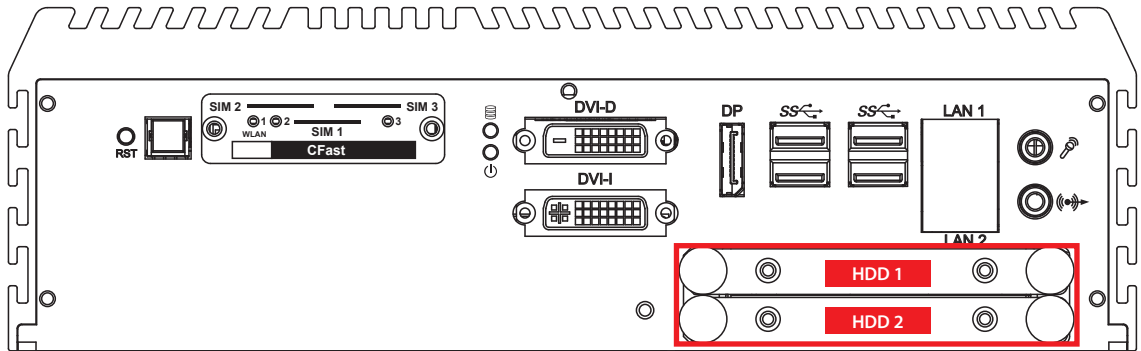

There are 2 front-access 2.5" SSD/HDD trays in the front side of ECS-9200/9100. Just trigger to open the SSD/HDD tray, up to 4TB is available.

## 2.3 Rear Panel I/O & Functions

### 2.3.1 Power Terminal Block

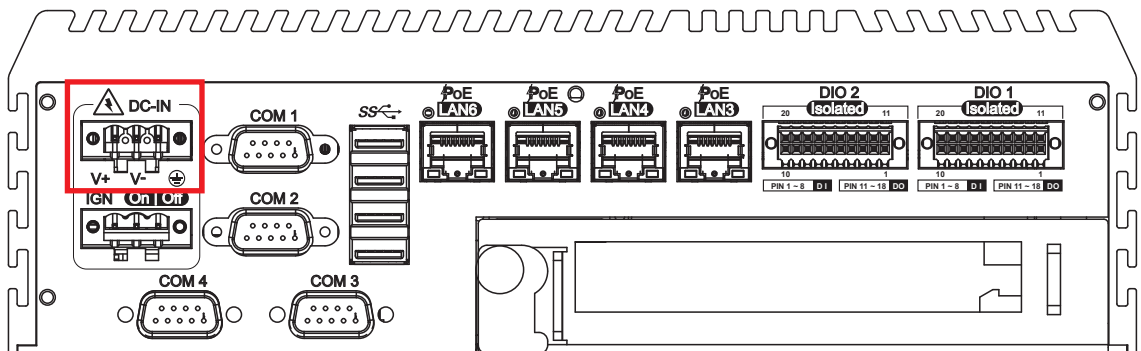

This system supports 6V to 36V DC power input by terminal block in the rear side. In normal power operation, power LED lightens in solid green and supports up to 80V surge protection.

Pin No.	Definition	Pin No.	Definition
1	V+	2	V-
3	Chassis Ground		

### 2.3.2 Remote Power On/Off Switch & Ignition

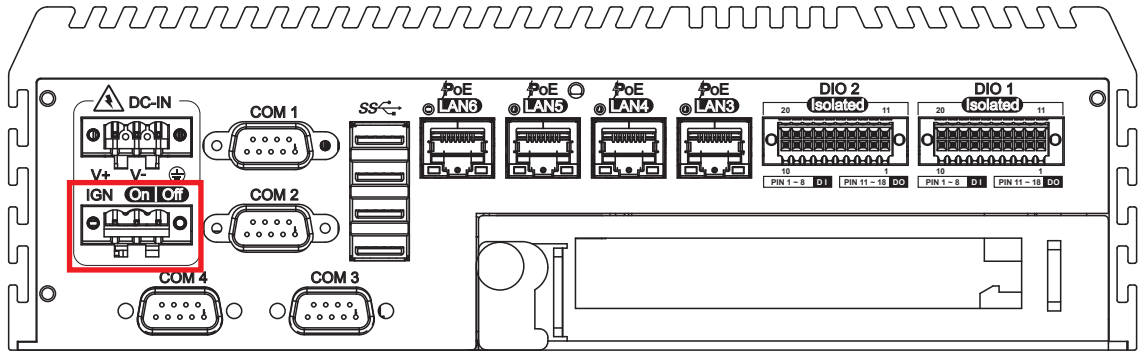

It is a 3-pin power-on or power-off switch through Phoenix Contact terminal block. You could turn on or off the system power by using this contact. This terminal block supports dual function of soft power-on/ power-off (instant off or delay 4 second), and suspend mode.

Pin No.	Definition	Pin No.	Definition
1	Ignition	2	External Power Button V+
3	External Power Button V-		

### 2.3.3 COM Ports

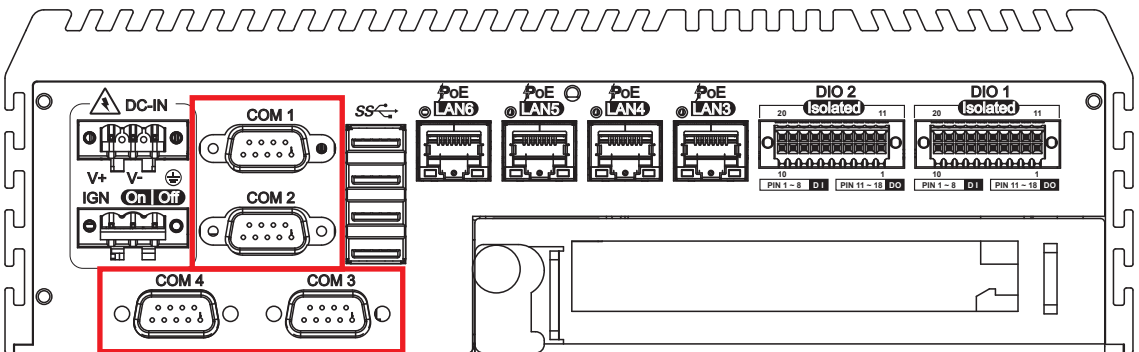

Serial port 1 to 4 (COM 1 to 4) can be configured for RS-232, RS-422, or RS-485 with auto flow control communication. The default definition of COM 1 and COM 2 is RS-232. If you want to change to RS-422 or RS-485, you can find the setting in BIOS.

BIOS Setting	Function
COM 1	RS-232
COM 2	RS-422 (5-wire)
	RS-422 (9-wire)
COM 3	RS-485
COM 4	RS-485 w/z auto-flow control

The pin assignments are listed in the table as below:

Serial Port	Pin No.	RS-232	RS-422 (5-wire)	RS-422 (9-wire)	RS-485 (3-wire)
1 to 4	1	DCD	TXD-	TXD-	DATA-
	2	RXD	TXD+	TXD+	DATA+
	3	TXD	RXD+	RXD+	-----
	4	DTR	RXD-	RXD-	-----
	5	GND	GND	GND	GND
	6	DSR	-----	RTS-	-----
	7	RTS	-----	RTS+	-----
	8	CTS	-----	CTS+	-----
	9	RI	-----	CTS-	-----

COM 3 & COM 4 MB connector table:

COM Port	MB Connector	COM Port	MB Connector
COM 3	CN9	COM 4	CN10

COM 3 & COM 4 MB connector pin out:

CN	Pin No.	Signal Name
CN9 (COM 3) CN10 (COM 4)	1	Chassis GND
	2	GND
	3	RI
	4	DTR
	5	CTS
	6	TXD
	7	RTS
	8	RXD
	9	DSR
	10	DCD

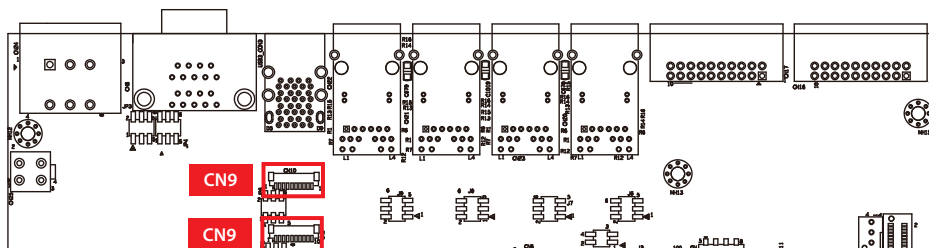

### 2.3.4 Rear USB 3.0

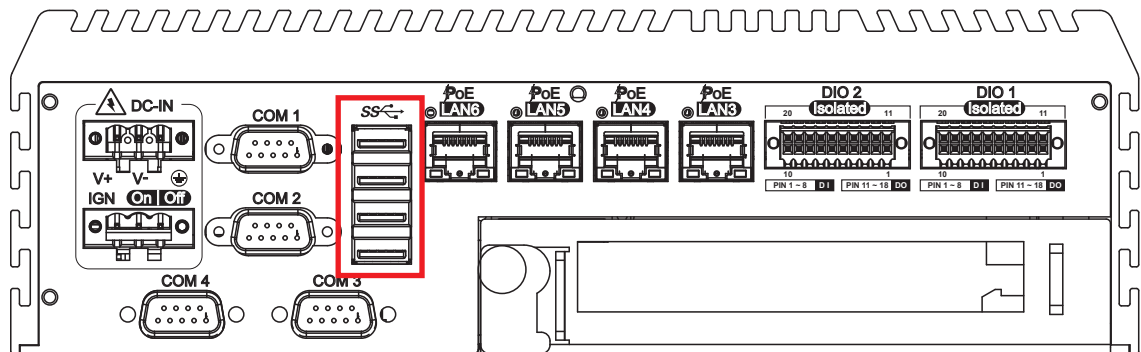

There are 4 USB 3.0 connections available supporting up to 5GB per second data rate in the rear side of ECS-9200/9100. It is also compliant with the requirements of Super Speed (SS), High Speed (HS), Full Speed (FS) and Low Speed (LS).

### 2.3.5 PoE (Power over Ethernet) Ports

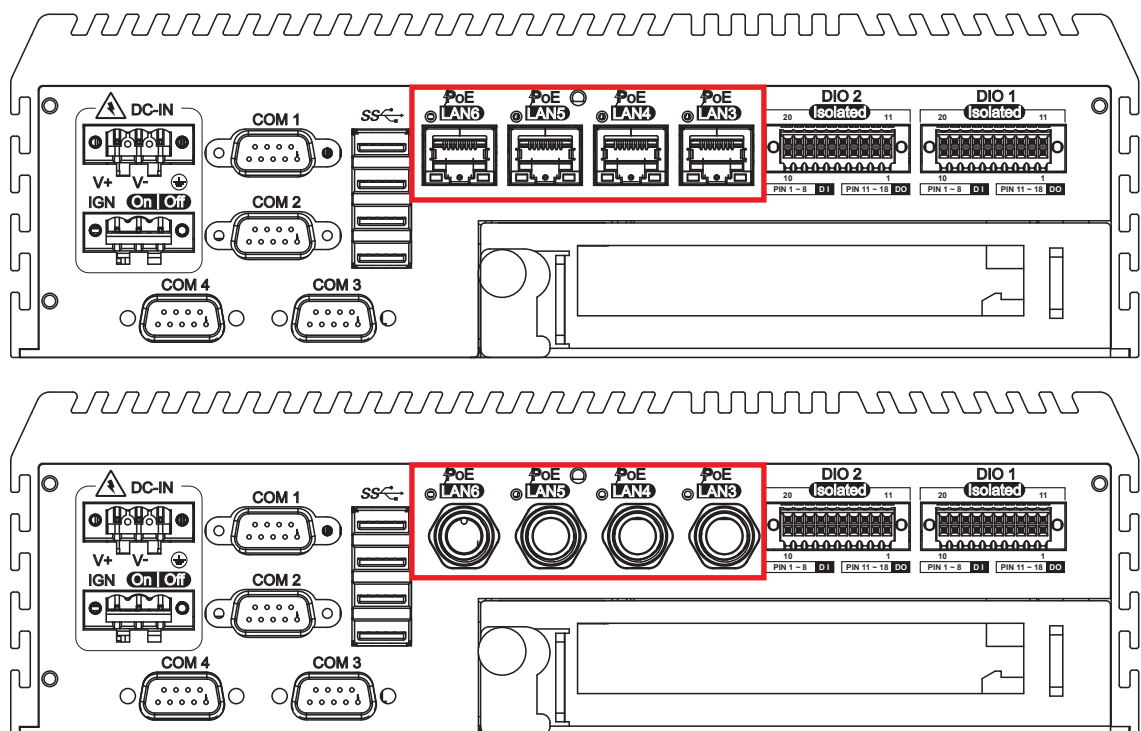

There are 4 RJ45 connectors or 4 M12 connectors in the rear side of ECS-9200/9200M. It supports IEEE 802.3at (PoE+) Power over Ethernet (PoE) connection delivering up to 30.4W/54V per port and 1000BASE-T GigE data signals over standard Ethernet Cat 5/Cat 6 cable. Each PoE connection is powered by Intel® I210 GigE Ethernet controller and independent PCI express interface to connect with multi-core processor for network and data transmit optimization. Only when PoE port starts to supply power to power devices, the dedicated LED will be lightened.

PS. Suggest to use PoE function when power input is over 12V.

The pin-outs of LAN3 to LAN6 are listed as follows:

Pin No.	10/100 Mbps	1000Mbps	PoE
1	E_TX+	MDI0_P	PoE+
2	E_TX-	MDI0_N	PoE+
3	E_RX+	MDI1_P	PoE-
4	----	MDI2_P	----
5	-----	MDI2_N	----
6	E_RX-	MDI1_N	PoE-
7	-----	MDI3_P	----
8	-----	MDI3_N	----

Each LAN port is supported by standard RJ-45 connector with LED indicators to present Active/Link/Speed status of the connection & PoE status LED.

The LED indicator on the right bottom corner lightens in solid green when the cable is properly connected to a 100Mbps Ethernet network. The LED indicator on the right bottom corner lightens in solid orange when the cable is properly connected to a 1000Mbps Ethernet network. The left LED will keep twinkling/off when Ethernet data packets are being transmitted/received.

LED Status	10Mbps	100Mbps	1000Mbps
Right Bottom Led	Off	Solid Green	Solid Orange
Left Bottom Led	Flash Yellow	Flash Yellow	Flash Yellow

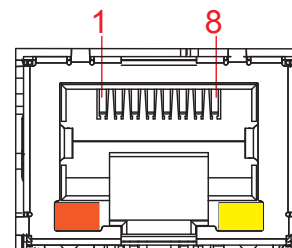

POE LED indicator:

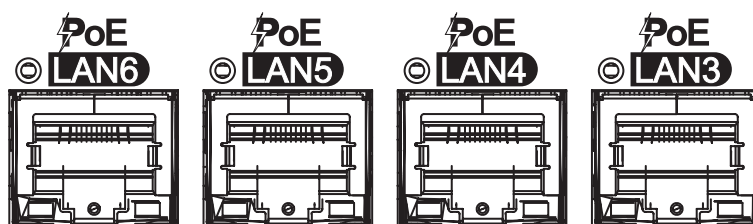

LED Location	LED Color	Status
LED 3 - 6	Solid Green	PoE ON

### 2.3.6 Isolated DIO

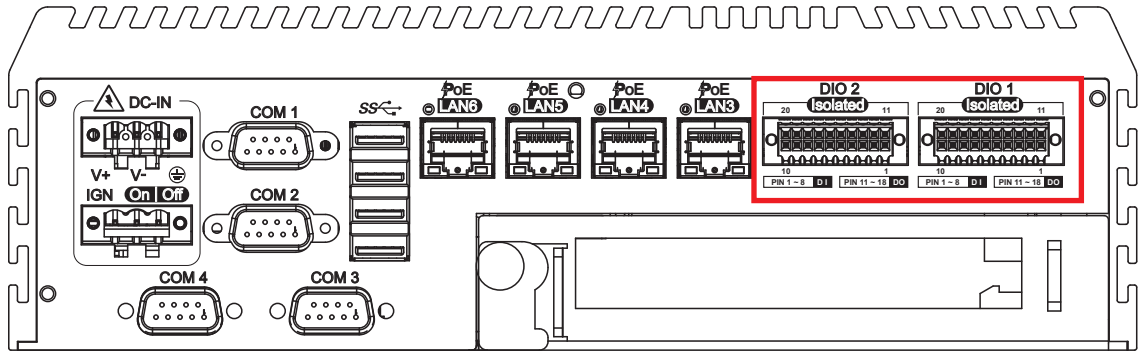

There is a 32-bit (16-bit DI, 16-bit DO) with 2 DIO connectors in the rear side. DI/DIO support NPN(sink) and PNP(Source) mode, Each DI channel is equipped with a photocouper for isolated protection. Each DO with isolator chip is configured by a software for each DIO connector. DO Safety-Related Certifications:

- 4242-VPK Basic Isolation per DIN V VDE V 0884-10 and DIN EN 61010-1
- 3-KVRMS Isolation for 1 minute per UL 1577
- CSA Component Acceptance Notice 5A, IEC 60950-1 and IEC 61010-1 End Equipment Standards
- GB4943.1-2011 CQC Certified

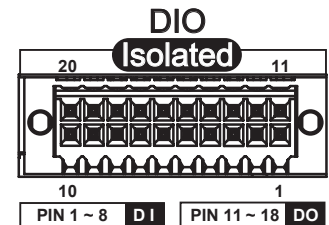

DIO Connectors pin out:

DIO	Pin No.	Definition	Function
DIO1	1	INPUT 0	SIO_GPI80
	2	INPUT 1	SIO_GPI81
	3	INPUT 2	SIO_GPI82
	4	INPUT 3	SIO_GPI83
	5	INPUT 4	SIO_GPI84
	6	INPUT 5	SIO_GPI85
	7	INPUT 6	SIO_GPI86
	8	INPUT 7	SIO_GPI87
	9	DI1_COM	-
	10	DIO1_GND	-
	11	OUTPUT 0	SIO_GPO70
	12	OUTPUT 1	SIO_GPO71
	13	OUTPUT 2	SIO_GPO72
	14	OUTPUT 3	SIO_GPO73
	15	OUTPUT 4	SIO_GPO74
	16	OUTPUT 5	SIO_GPO75
	17	OUTPUT 6	SIO_GPO76
	18	OUTPUT 7	SIO_GPO77
	19	DIO1_GND	-
	20	DIO1_VDC (6~48V Input)	-



DIO	Pin No.	Definition	Function
DIO2	1	INPUT 0	SIO_GPI37
	2	INPUT 1	SIO_GPI56
	3	INPUT 2	SIO_GPI57
	4	INPUT 3	SIO_GPI15
	5	INPUT 4	SIO_GPI16
	6	INPUT 5	SIO_GPI35
	7	INPUT 6	SIO_GPI46
	8	INPUT 7	SIO_GPI11
	9	DI2_COM	-
	10	DIO2_GND	-
	11	OUTPUT 0	SIO_GPO22
	12	OUTPUT 1	SIO_GPO26
	13	OUTPUT 2	SIO_GPO64
	14	OUTPUT 3	SIO_GPO65
	15	OUTPUT 4	SIO_GPO41
	16	OUTPUT 5	SIO_GPO40
	17	OUTPUT 6	SIO_GPO52
	18	OUTPUT 7	SIO_GPO27
	19	DIO2_GND	-
	20	DIO2_VDC (6~48V Input)	-

DI reference circuit:

Sink Mode (NPN)

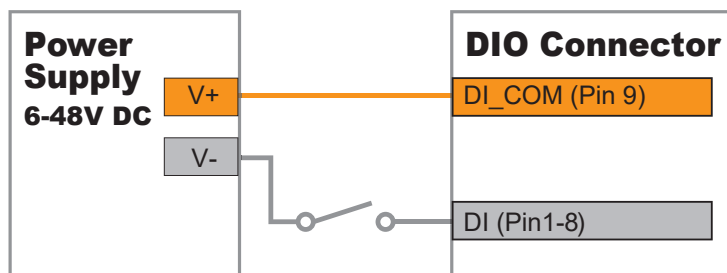

Source Mode (PNP)

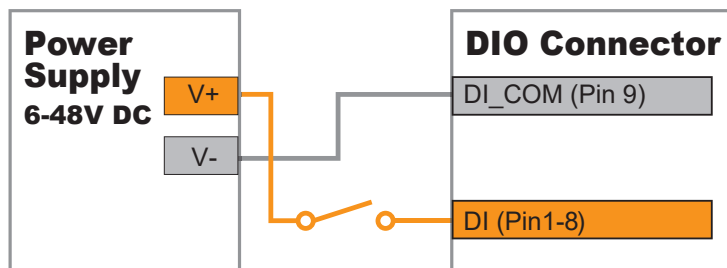

DO reference circuit:

Sink Mode  
(NPN, Default)

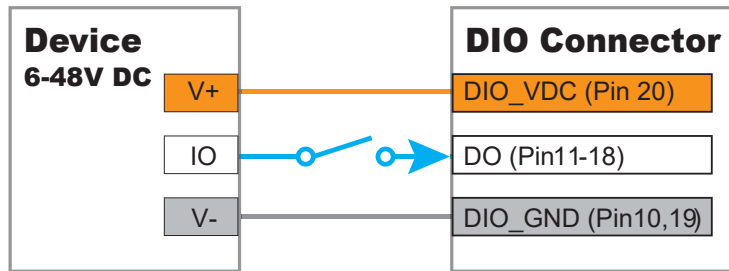

Source Mode  
(PNP)

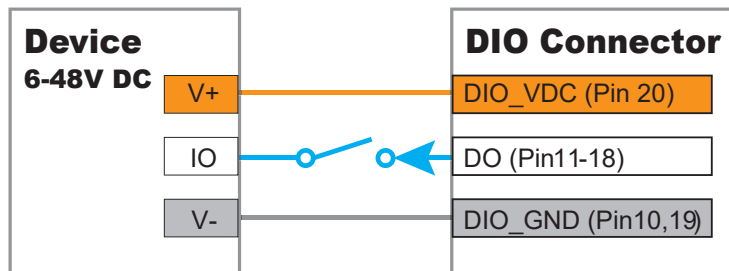

### 2.3.7 Add Card

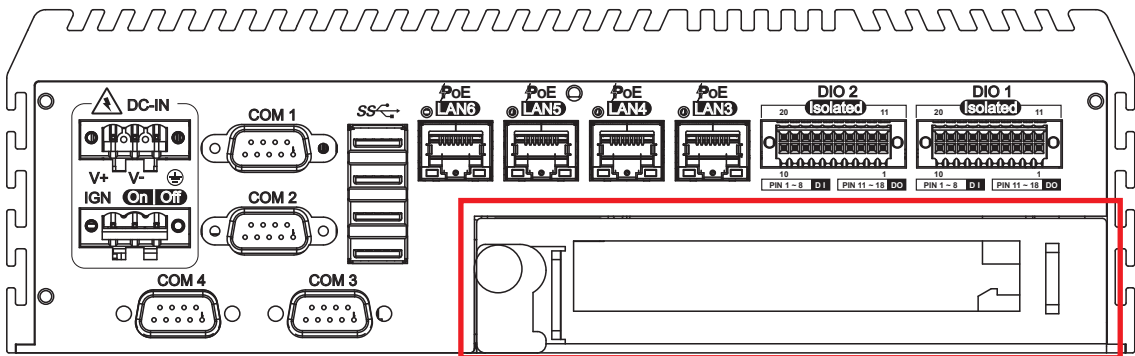

Optional for PCIe16 FHHL add on card or PCI card.



## 2.4.2 UPS Power Connector

For UPS module optional, we use 4.2mm 2x2p power connector.  
This system has a UPS power input connector for Optional part UPS Module.

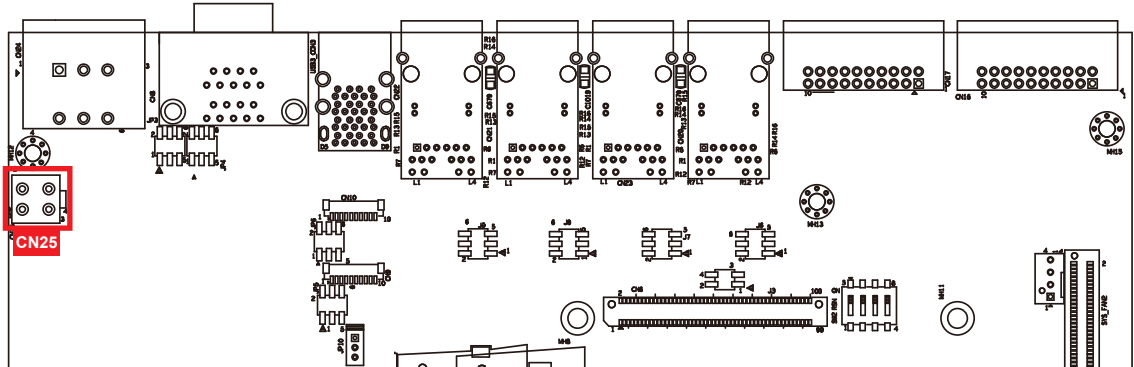

Pin No.	Definition	Pin No.	Definition
1	Ground	2	Ground
3	+VDC_IN (6~36V, Max.8A)	4	+VDC_IN (6~36V, Max.8A)

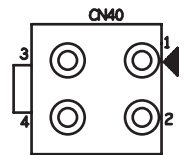

## 2.4.3 Miscellaneous Pin Header

2.0mm 2x4p header

This pin header can be used as a backup for following functions, such as hard drive LED indicator, reset button, power LED indicator, and power-on/ off button, which already can be accessed by front panel and top panel. The pin-outs of Miscellaneous port are listed in following table:

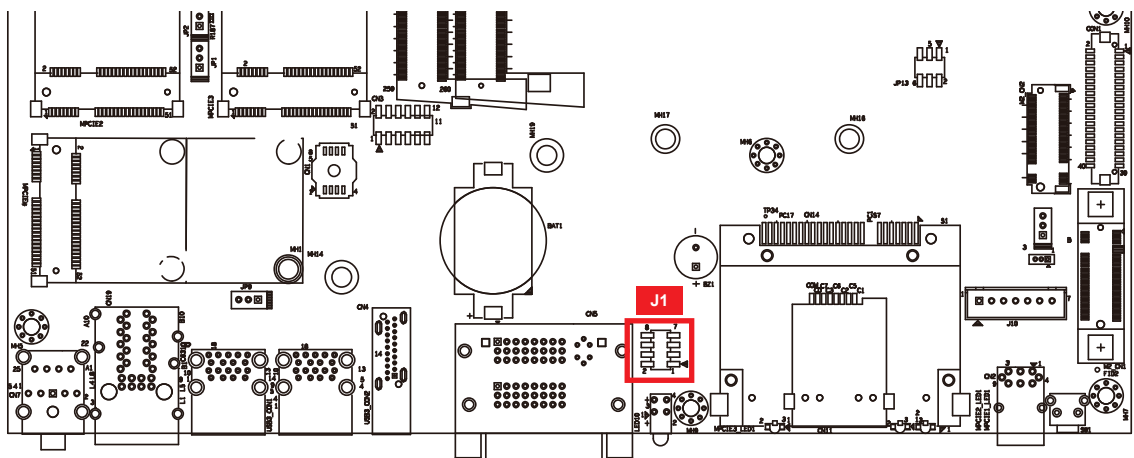

Group	Pin No.	Description
HDD LED	1	HDD_LED_P
	3	HDD_LED_N
RESET BUTTON	5	FP_RST_BTN_N
	7	Ground
POWER LED	2	PWR_LED_P
	4	PWR_LED_N
POWER BUTTON	6	FP_PWR_BTN_IN
	8	Ground

## 2.4.4 DDR4 Slot

There are 2 DDR4 channel onboard supporting DDR4 2400/2133 MHz and up to 64GB. (Each channel 32GB)

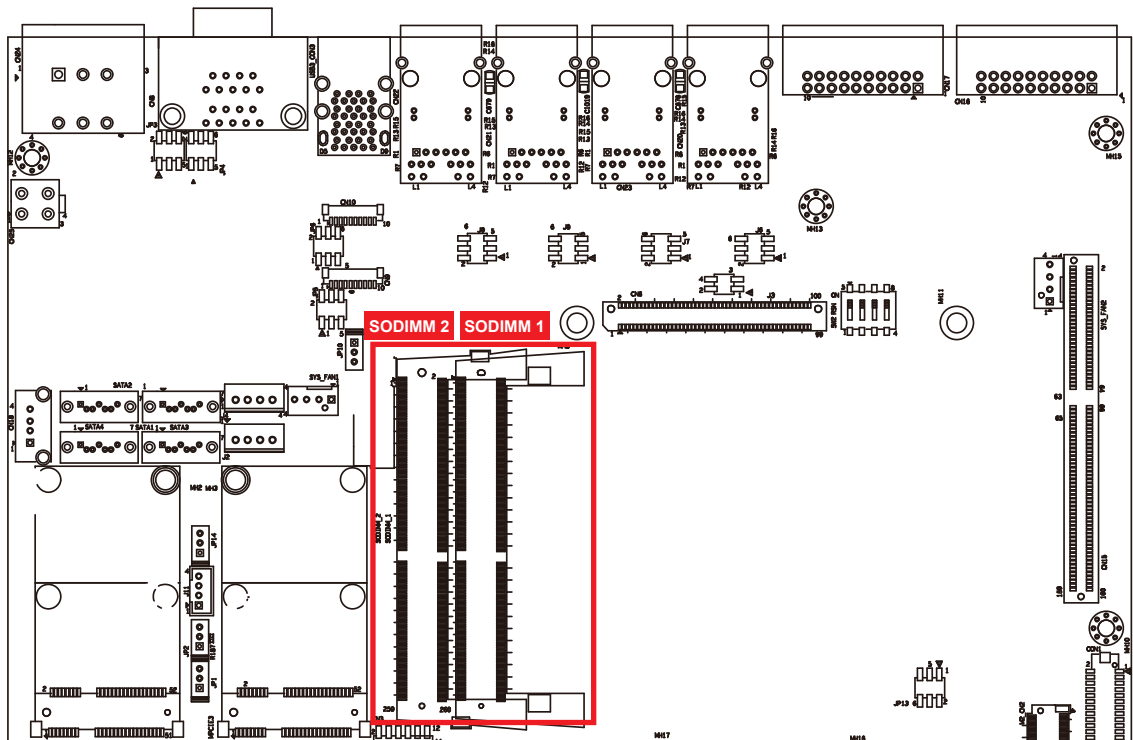

Slot	Description	Slot	Description
SODIMM_1	DDR4 Channel A	SODIMM_2	DDR4 Channel B

## 2.4.5 BIOS Socket

If the BIOS needs to be changed, please contact the Vecow RMA service team.

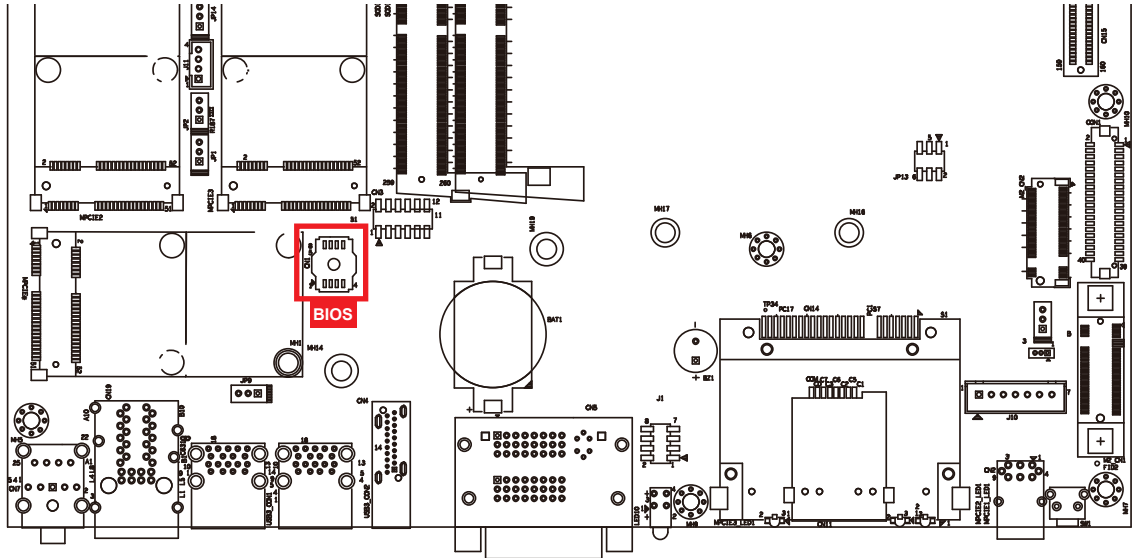

## 2.4.6 SATA Connector

Standard 7 PIN SATA Connector

There are 2 onboard high performance Serial ATA III. It supports higher storage capacity with less cabling effort and smaller required space.

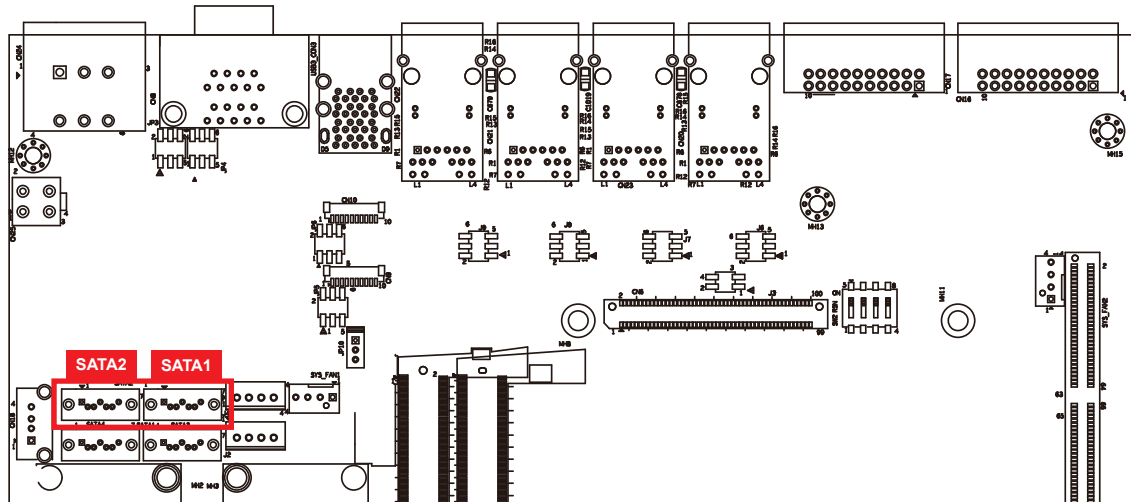

Pin No.	Definition
1	Ground
2	TX DP
3	TX DN
4	Ground

Pin No.	Definition
5	RX DN
6	RX DP
7	Ground

## 2.4.7 SATA Power Header

Standard, all form factor 1x4p power header

There are 2 HDD power header on board and each power header supports two 2.5" SATA HDD.

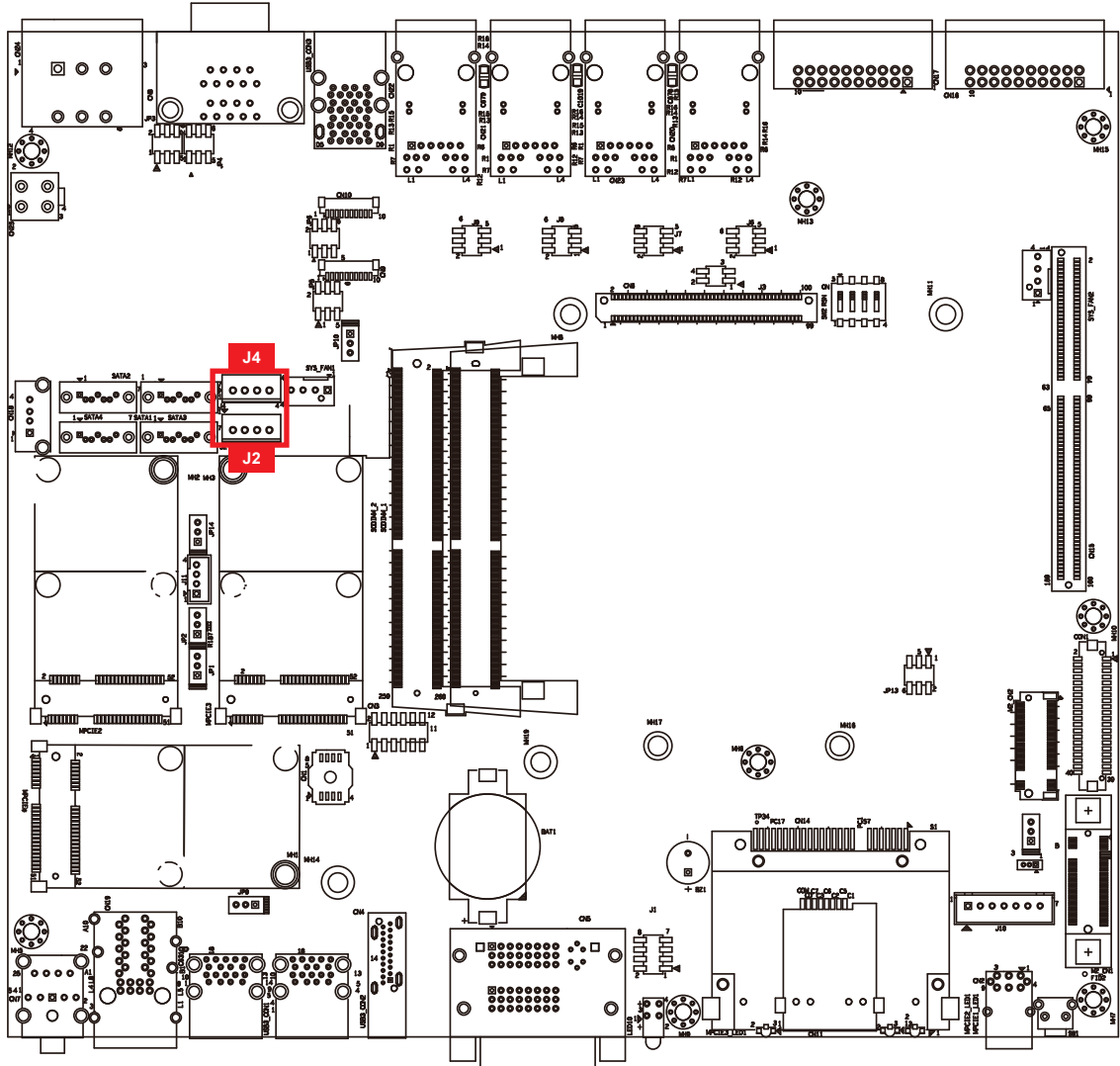

Pin No.	Description	Pin No.	Description
1	+V5 (Max. 4A)	2	Ground
3	Ground	4	+V12 (Max. 1.5A)

## 2.4.8 Internal USB2.0

### Standard Vertical USB2.0 Connector

The ECS-9200/9100 main board provides one expansion USB port using plug-and-play for Dongle Key or LCD touch Panel. The USB interface supports 480 Mbps transfer rate complied with high speed USB specification Rev. 2.0.

The USB interface is accessed through one standard USB 2.0 connector. This USB 2.0 does not support wake up function.

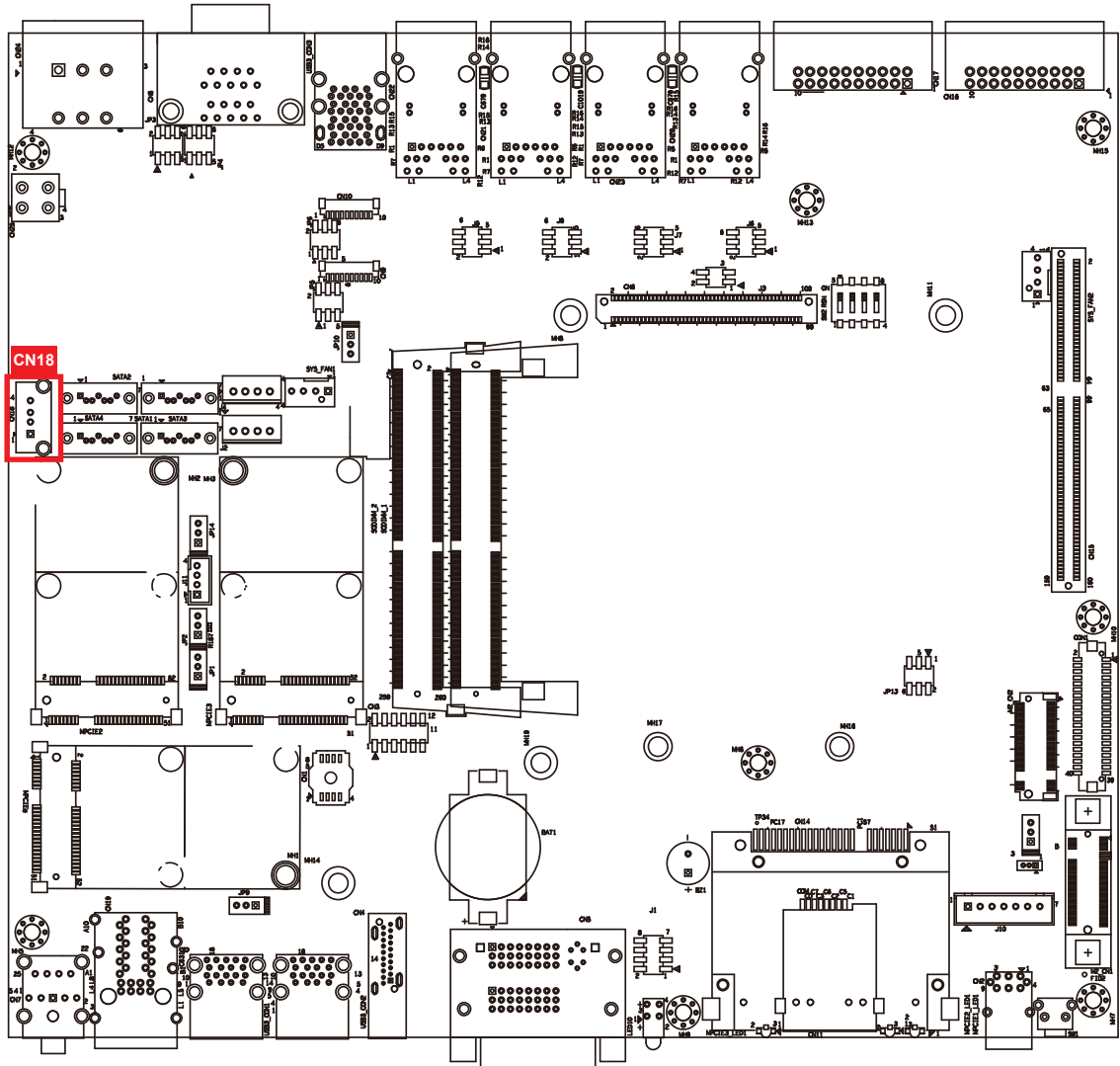

Pin No.	Definition	Pin No.	Definition
1	USB +VCC (+V5/Max. 0.5A)	2	DATA-
3	DATA+	4	Ground



## 2.4.10 M.2

Standard Type 2280 M.2 (M key) slot:

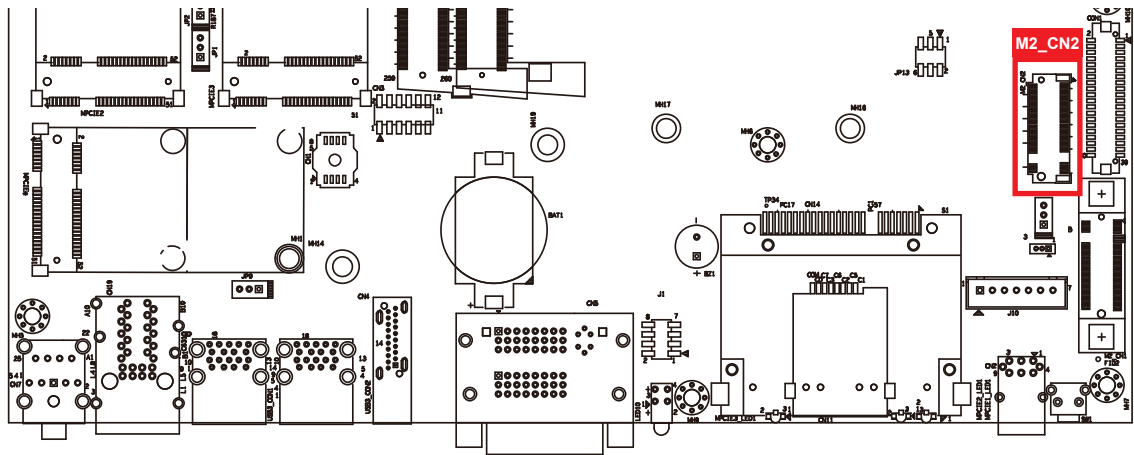

Pin Out:

Pin No.	Function	Pin No.	Function
75	GND		
73	GND	74	+3.3V
71	GND	72	+3.3V
69	PEDET (NC-PCIe/GND-SATA)	70	+3.3V
67	N/C	68	N/C
Mechanical Key			
57	GND	58	N/C
55	REFCLKp	56	N/C
53	REFCLKn	54	WAKE#
51	GND	52	CLKREQ#
49	PETp0 /SATA-A+	50	PERST#
47	PETn0 /SATA-A-	48	N/C
45	GND	46	N/C
43	PERp0 /SATA-B-	44	N/C
41	PERn0 /SATA-B+	42	N/C
39	GND	40	N/C
37	PETp1	38	DEVSLP
35	PETn1	36	N/C
33	GND	34	N/C

31	PERp1	32	N/C
29	PERn1	30	N/C
27	GND	28	N/C
25	PETp2	26	N/C
23	PETn2	24	N/C
21	GND	22	N/C
19	PERp2	20	N/C
17	PERn2	18	+3.3V
15	GND	16	+3.3V
13	PETp3	14	+3.3V
11	PETn3	12	+3.3V
9	GND	10	DAS/DSS# (I/O)/LED1# (I)(0/3.3V)
7	PERp3	8	N/C
5	PERn3	6	N/C
3	GND	4	+3.3V
1	GND	2	+3.3V

## 2.4.11 Mini PCIe

Standard full length Mini PCIe slot:

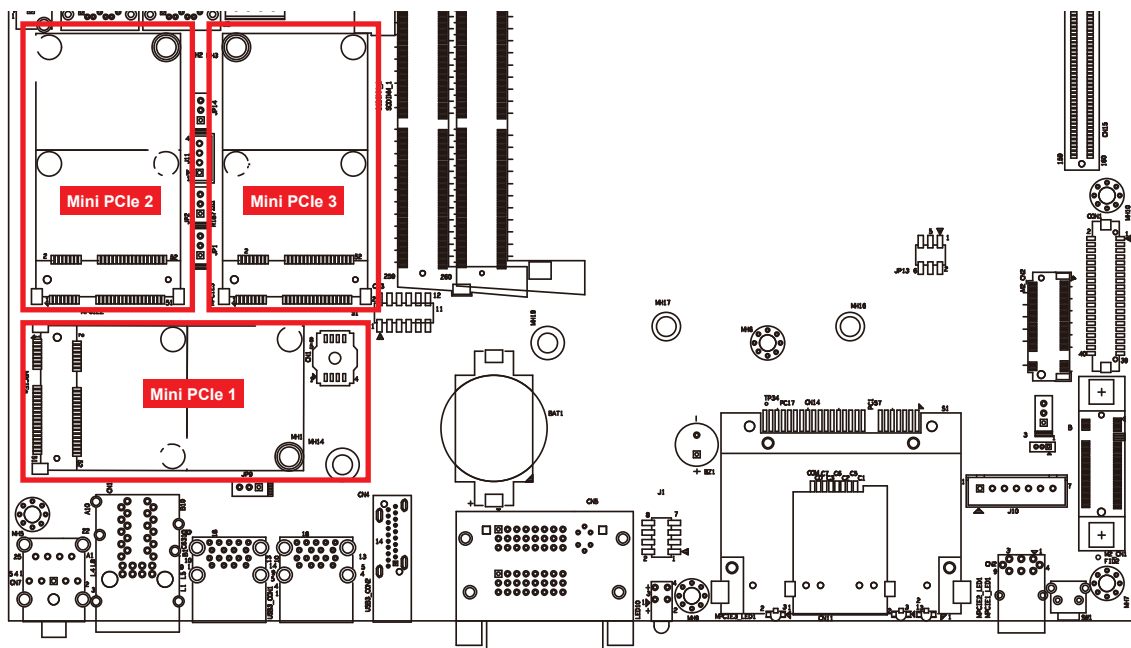

Pin Out:

Pin No.	Function	Pin No.	Function
51	Reserved	52	+3.3Vaux
49	Reserved	50	GND
47	Reserved	48	+1.5V
45	Reserved	46	Reserved
43	GND	44	Reserved
41	+3.3Vaux	42	Reserved
39	+3.3Vaux	40	GND
37	GND	38	USB_D+
35	GND	36	USB_D-
33	PETp0	34	GND
31	PETn0	32	SMB_DATA
29	GND	30	SMB_CLK
27	GND	28	+1.5V
25	PERn0	26	GND
23	PERp0	24	+3.3Vaux
21	GND	22	PERST#
19	Reserved	20	reserved
17	Reserved	18	GND
Mechanical Key			
15	GND	16	UIM_VPP
13	REFCLK+	14	UIM_RESET
11	REFCLK-	12	UIM_CLK
9	GND	10	UIM_DATA
7	CLKREQ#	8	UIM_PWR
5	Reserved	6	1.5V
3	Reserved	4	GND
1	WAKE#	2	3.3Vaux

## 2.4.12 RTC Battery

The system's real-time clock is powered by a lithium battery. It is equipped with Panasonic BR2032 190mAh lithium battery. It is recommended that you do not have to get the lithium battery on your own. If the battery needs to be changed, please contact the Vecow RMA service team.

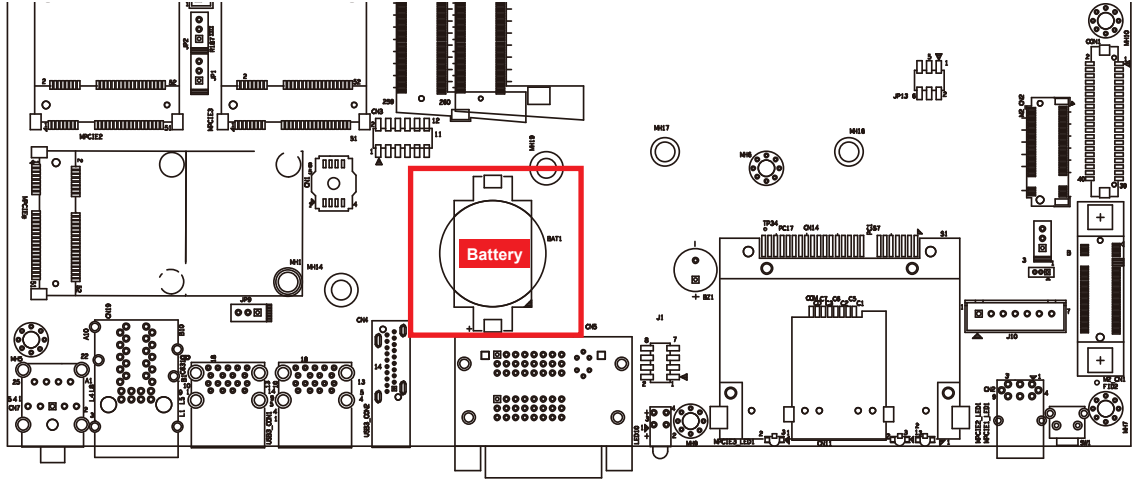

## 2.4.13 FAN Header

Fan power connector supports for additional thermal requirements. The pin assignments of FAN 1 and FAN 2 are listed in the following diagram:

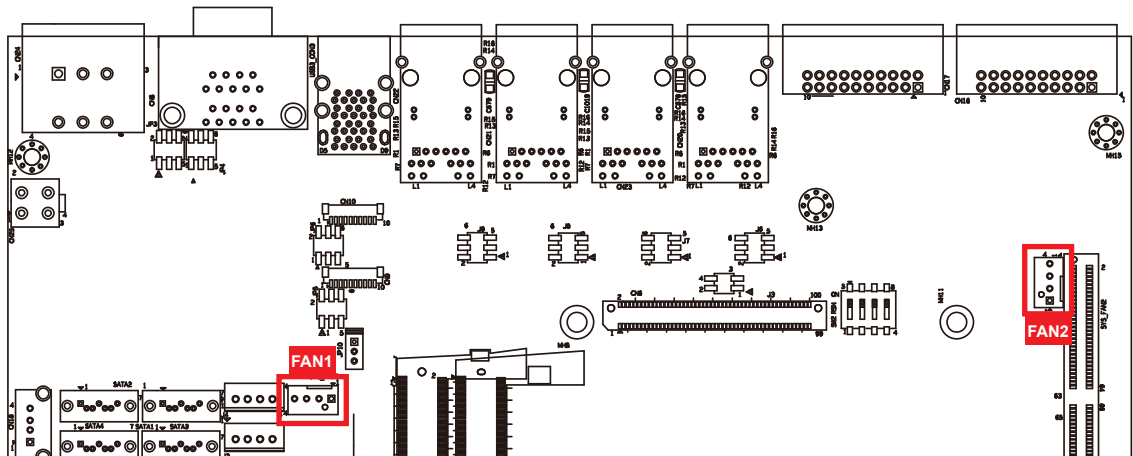

Pin out:

Pin No.	Function	Pin No.	Function
1	GND	2	+12V (1.5A max)
3	Fan speed sensor	4	Fan PWM

## 2.4.14 LPC Port 80 Header

ECS-9200/9100 provides a LPC Port 80 Header for Debug Card.

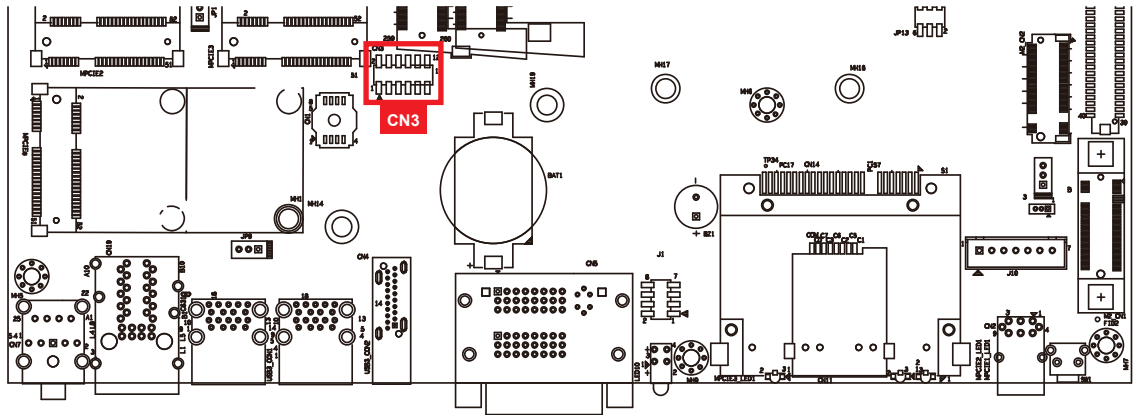

Pin out:

Pin No.	Function	Pin No.	Function
1	SERIRQ	7	LFRAME#
2	+3.3V	8	LAD0
3	LA3	9	N/C
4	RESET#	10	Ground
5	LAD1	11	CLOCK
6	LAD2	12	Ground

## 2.4.15 LAN IEEE 1588 Header

ECS-9200 provides a LAN header for IEEE 1588.

LAN No.	Function	Function
Rear POE LAN3	Intel I210	J6
Rear POE LAN4	Intel I210	J7
Rear POE LAN5	Intel I210	J8
Rear POE LAN6	Intel I210	J9

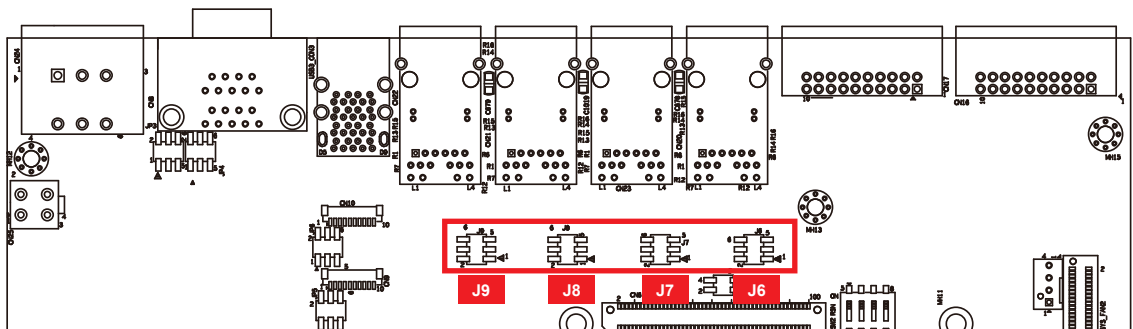

Pin out:

Pin No.	Function	Pin No.	Function
1	SPD0	2	SPD1
3	SPD2	4	SPD3
5	Ground	6	Ground

## 2.4.16 COM Port Header

ECS-9200/9100 provides 4 COM port headers for internal COM port cable.

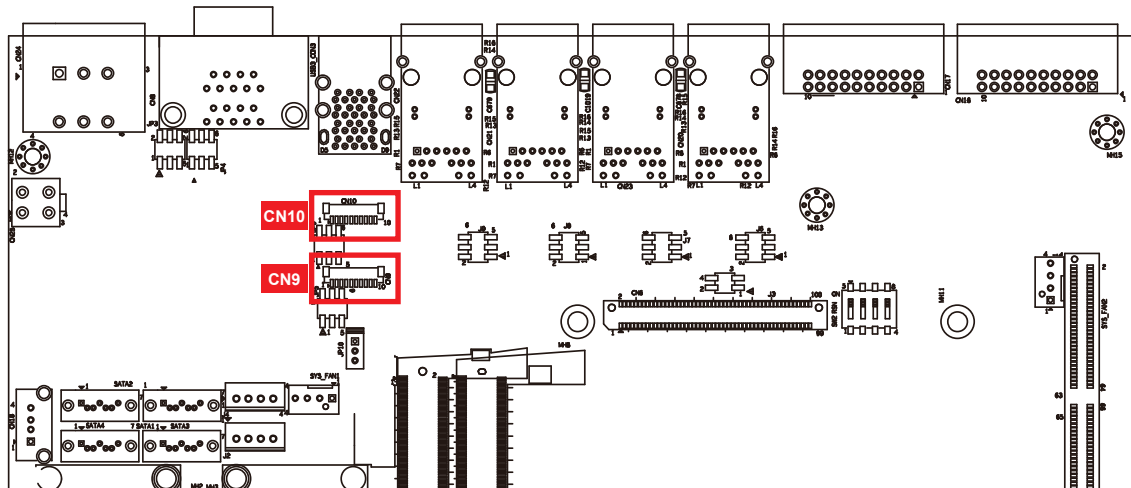

Pin out:

CN9:

Pin No.	Description	Port
1	Ground_Frame	COM3
2	Ground	COM3
3	RI	COM3
4	DTR	COM3
5	CTS	COM3
6	TXD	COM3
7	RTS	COM3
8	RXD	COM3
9	DSR	COM3
10	DCD	COM3

CN10:

Pin No.	Description	Port
1	Ground_Frame	COM4
2	Ground	COM4
3	RI	COM4
4	DTR	COM4
5	CTS	COM4
6	TXD	COM4
7	RTS	COM4
8	RXD	COM4
9	DSR	COM4
10	DCD	COM4

## 2.5 Main Board Jumper & DIP Switch Settings

### 2.5.1 Top View of ECS-9200/9100 With Jumper and DIP Switch

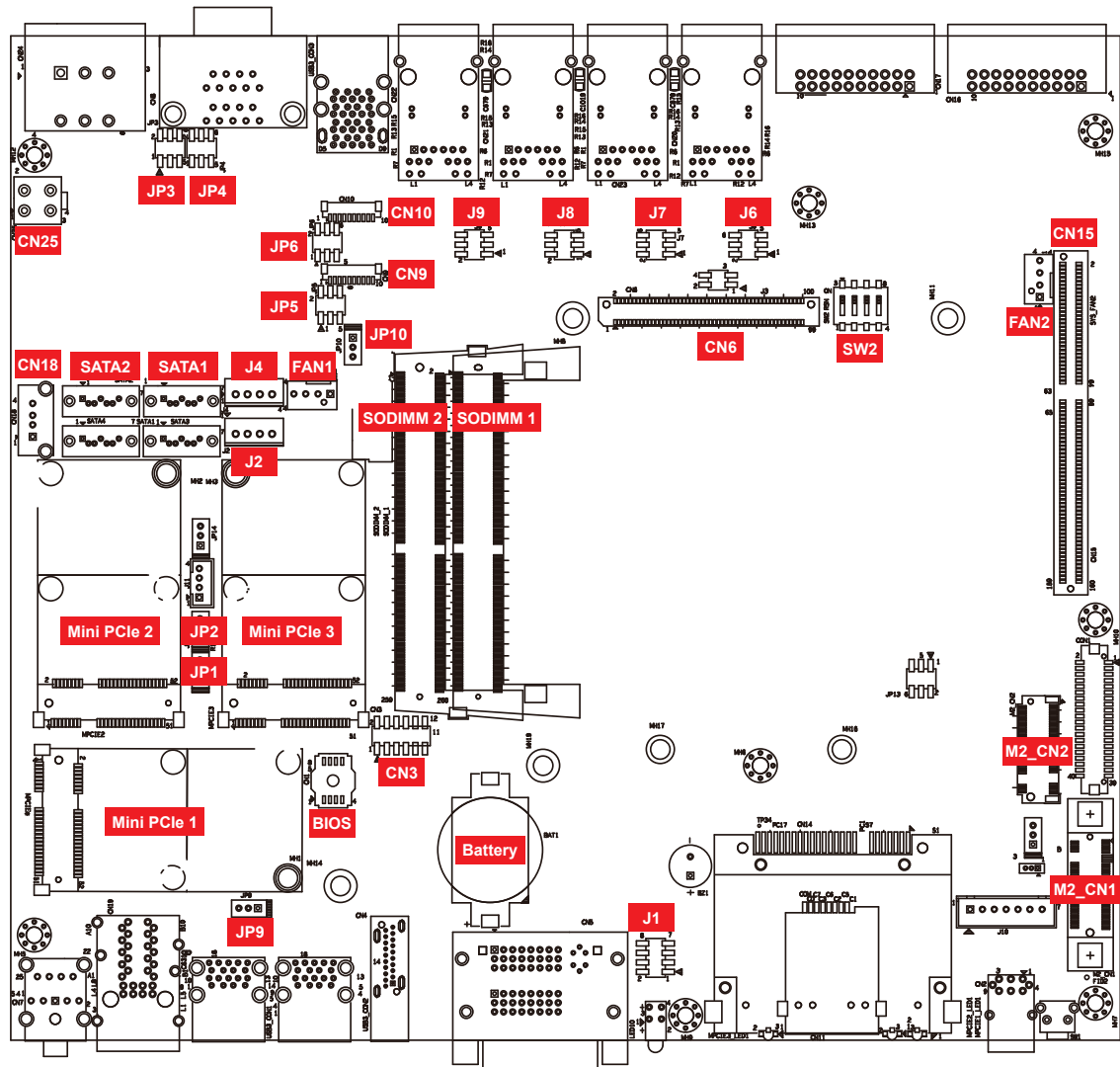

The figure below is the top view of ECS-9200/9100 main board which is the main board. It shows the location of the jumpers and the switches.

You may configure your card to match the needs of your application by setting jumpers. A jumper is a metal bridge used to close an electric circuit. It consists of two metal pins and a small metal clip (often protected by a plastic cover) that slides over the pins to connect them. To “close” a jumper, you connect the pins with the clip. To “open” a jumper, you remove the clip. Sometimes a jumper will have three pins, labeled 1, 2 and 3. In this case you would connect either pins 1 and 2, or 2 and 3.

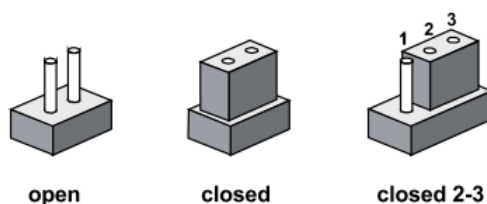

You may configure your card to match the needs of your application by DIP switch. As below show the DIP switch on and off.

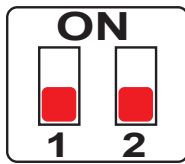

1 : OFF  
2 : OFF

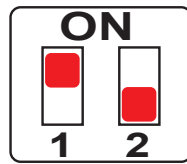

1 : ON  
2 : OFF

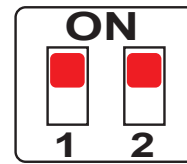

1 : ON  
2 : ON

## 2.5.2 USB Power Jumper

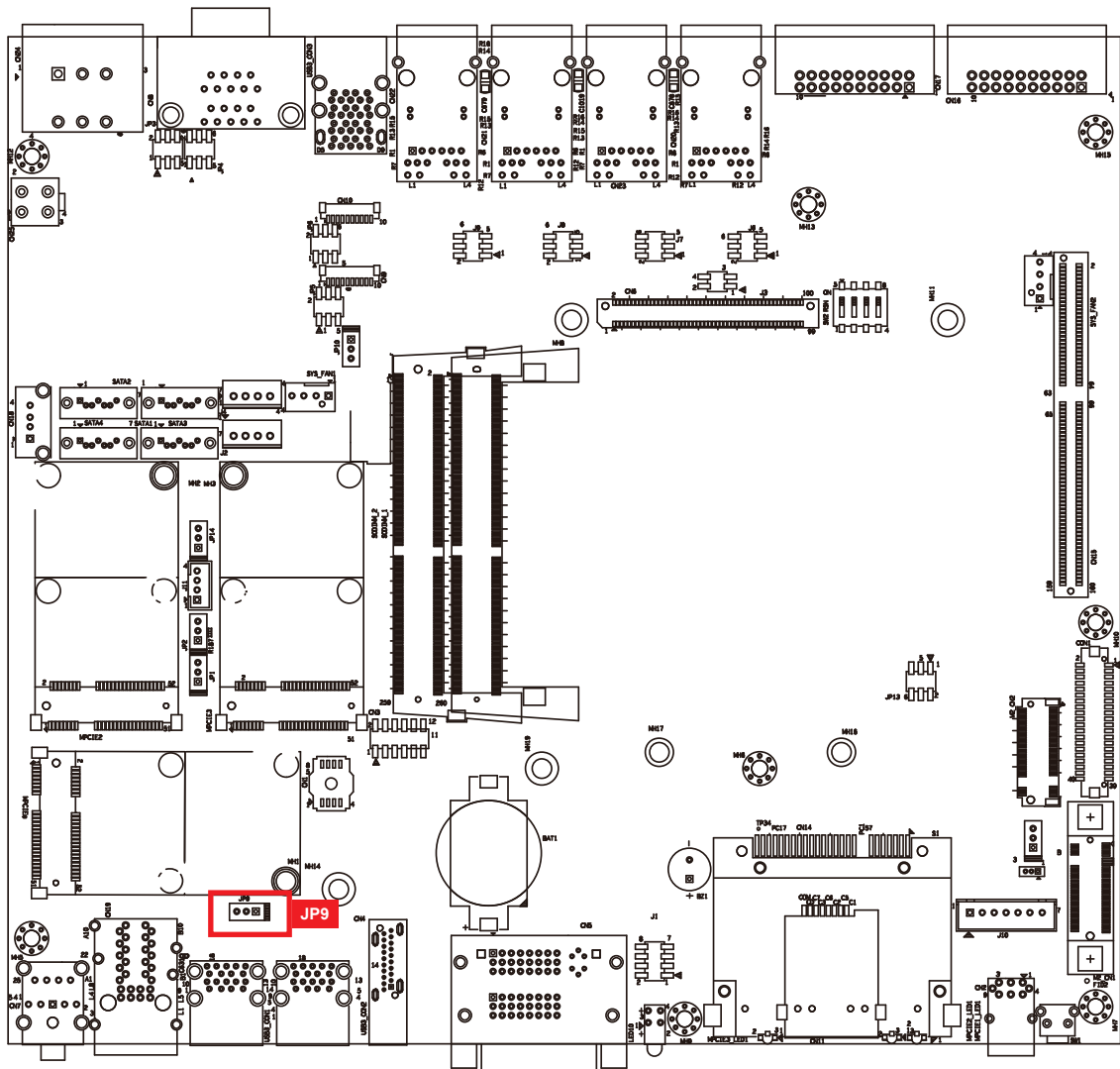

Jumper	Setting	Function
JP9	1:2	Supported Wake Up (Default)
JP9	2:3	Non Wake Up support





## 2.5.4 POE Power ON Select

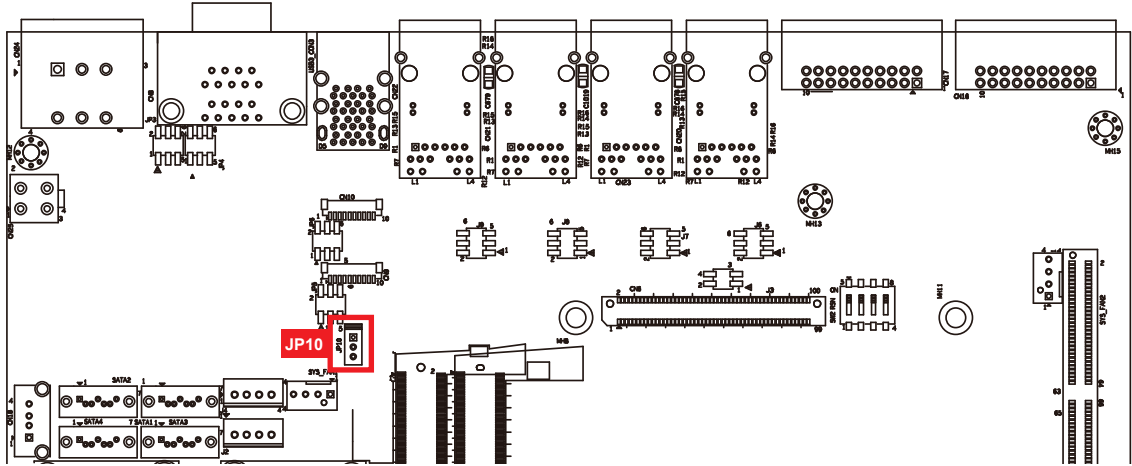

Jumper	Setting	Function
JP10	1:2	POE power on at standby power ready
JP10	2:3	POE power on after system power on (Default)

## 2.5.6 Clear CMOS/ME Switch

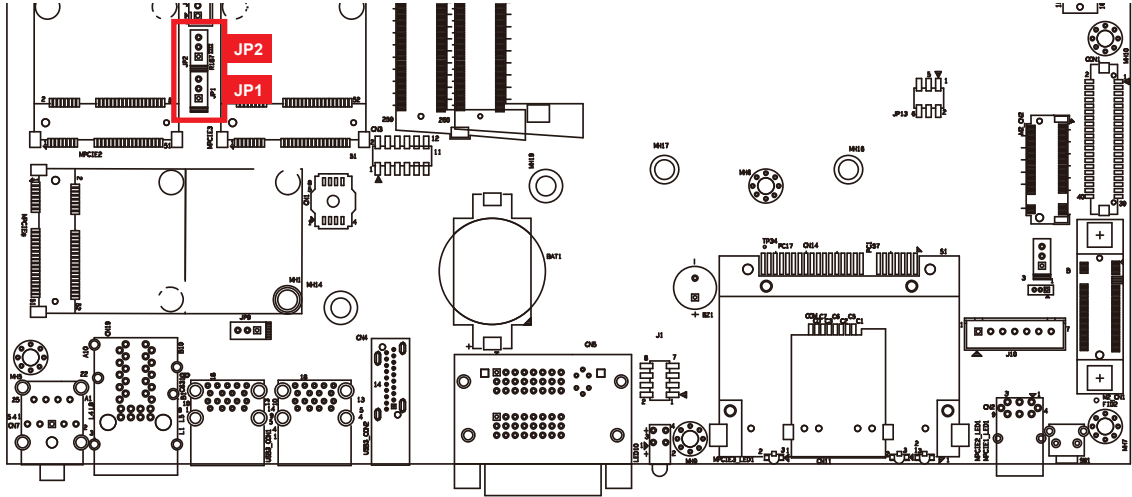

Jumper	Setting	Function
JP1	1:2	*Normal (Default)
JP1	2:3	Clear CMOS

Jumper	Setting	Function
JP2	1:2	*Normal (Default)
JP2	2:3	Clear ME

## 2.6 Ignition Control







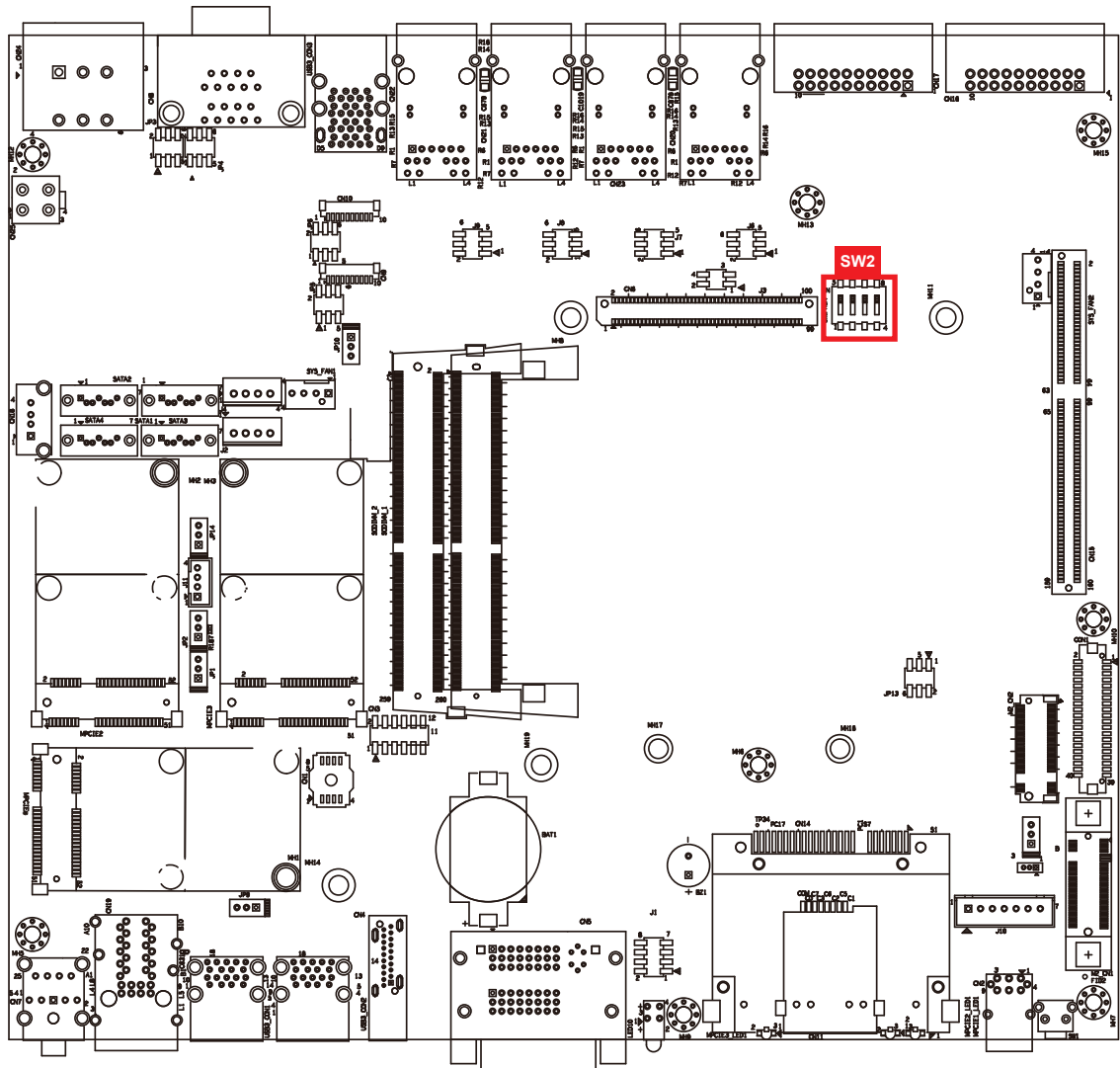



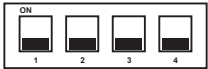

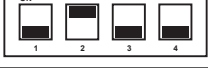



ECS-9200/9100 series provides ignition power control feature for in-vehicle applications. The built-in MCU monitors the ignition signal and turns on/off the system according to pre-defined on/off delay period.

### 2.6.1 Adjust Ignition Control Modes

ECS-9200/9100 series provides 16 modes of different power on/off delay periods adjustable via SW2 switch. The default rotary switch is set to 0 in ATX/AT power mode.



The modes are listed in the following table:

Item	Power on delay	Power off delay	Switch Position
0	ATX mode		
1	No delay	No delay	
2	No delay	5 seconds	
3	No delay	10 seconds	
4	No delay	20 seconds	
5	5 seconds	30 seconds	
6	5 seconds	60 seconds	
7	5 seconds	90 seconds	
8	5 seconds	30 minutes	
9	5 seconds	1 hour	
A	10 seconds	2 hours	
B	10 seconds	4 hours	
C	10 seconds	6 hours	
D	10 seconds	8 hours	
E	10 seconds	12 hours	
F	10 seconds	24 hours	

## 2.6.2 Ignition Control Wiring

To activate ignition control, you need to provide IGN signal via the 3-pin pluggable terminal block located in the back panel. It is below the general wiring configuration.

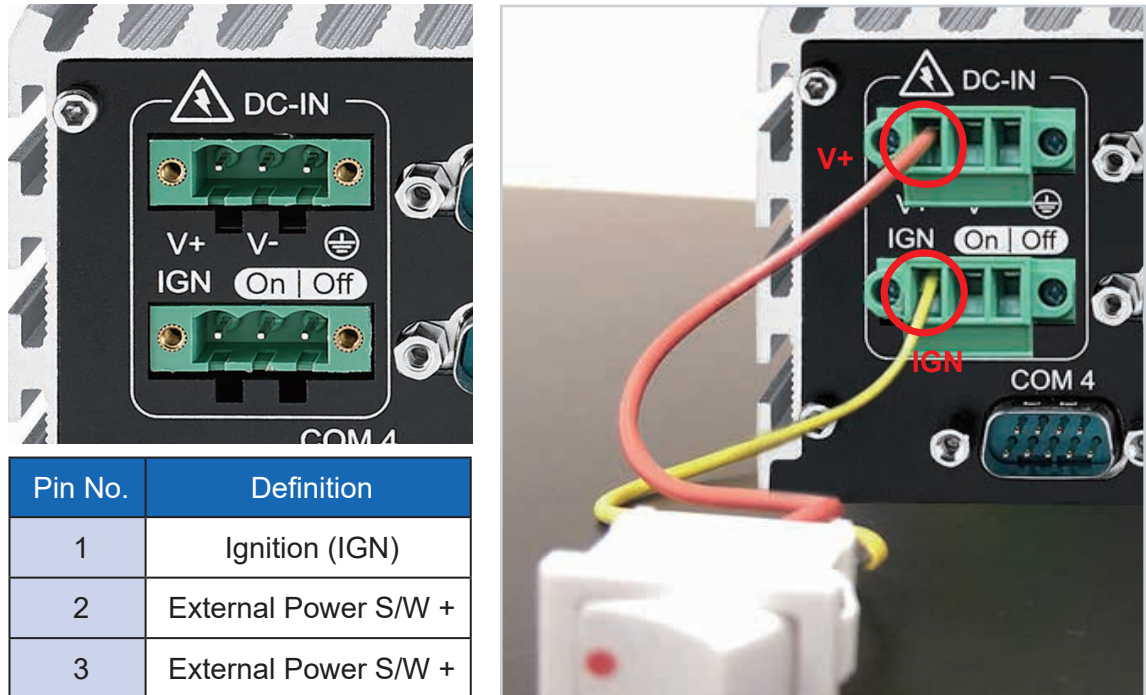

For testing purpose, you can refer to the picture below to simulate ignition signal input controlled by a latching switch.

Note:

1. DC power source and IGN share the same ground.
2. ECS-9200/9100 supports 6V~36V wide range DC power input in ATX/AT mode. In Ignition mode, the input voltage is fixed to 12V/24V for car battery scenario.
3. For proper ignition control, the power button setting should be "Power down" mode.

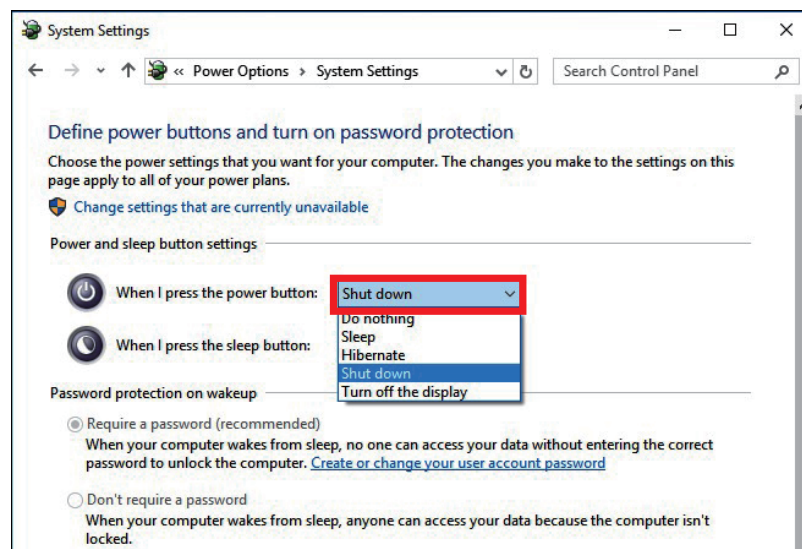

In Windows, for example, you need to set "When I press the power button" to "Shut down."

### 2.6.3 Smart Battery Protection

The system with “Ignition Control” can perform Smart Battery Protection, namely Low Battery Detection.

When the system is running on a battery and its voltage drops below the threshold, the system will automatically shut down. The Low Battery Detection is implemented in the ignition control MCU FW and as a default function.

Note:

Battery Voltage	Thresholds
12V	10.5~15V
24V	21.5~30V

# 3

## SYSTEM SETUP

### 3.1 How to Open Your ECS-9200/9100

**Step 1** Remove hole plugs.



**Step 2** Remove two F#6-32 screws (circled in red) and two F-M3 screws (circled in yellow) on the bottom side.

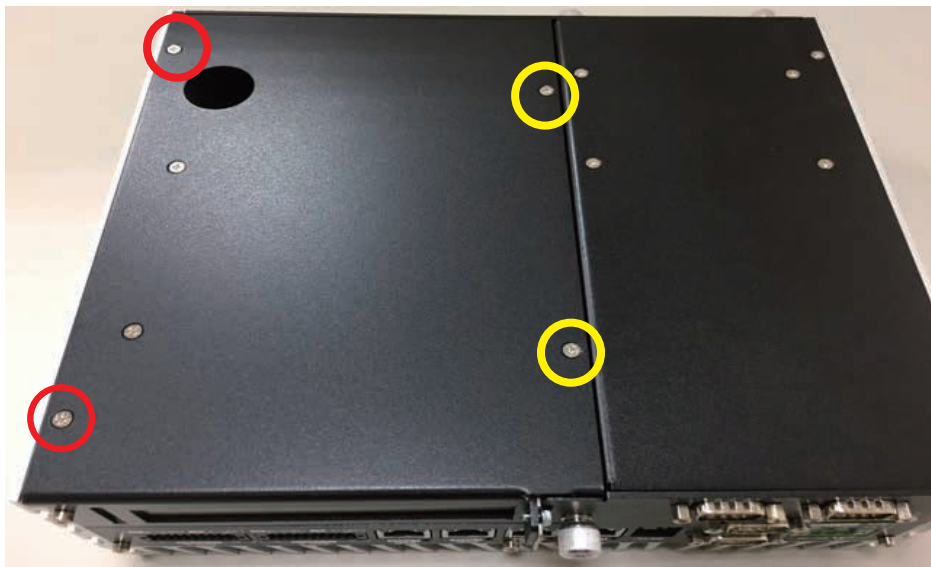

**Step 3** Finish Step1 and 2.



**Step 4** Remove one cover.



**Step 5** Open the module.





**Step 6** Finish.

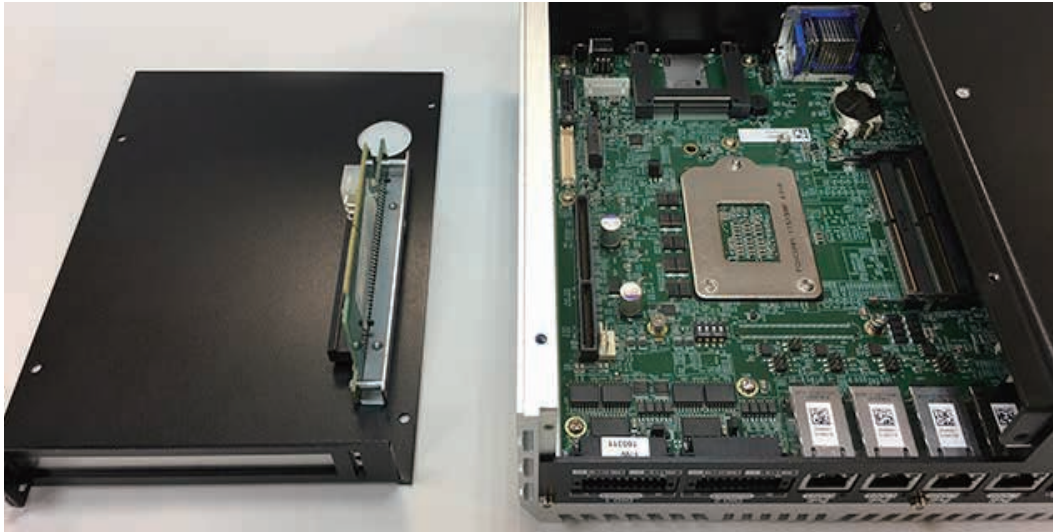

**Step 7** Remove two F-#6-32 screws at bottom side.



**Step 8** Remove one cover. Remove one screw KHS-#6-32 and SSD/HDD tray at front panel.

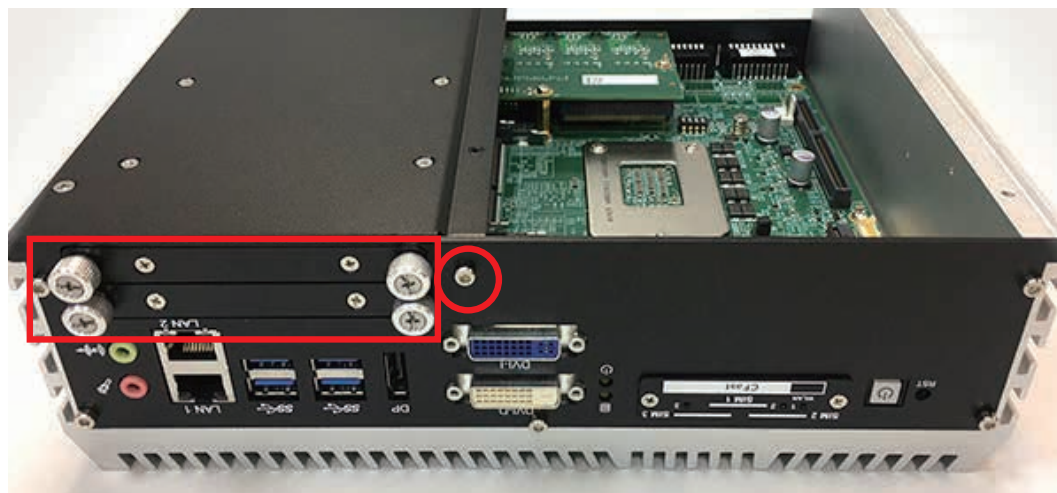

**Step 9** Remove SSD/HDD module.

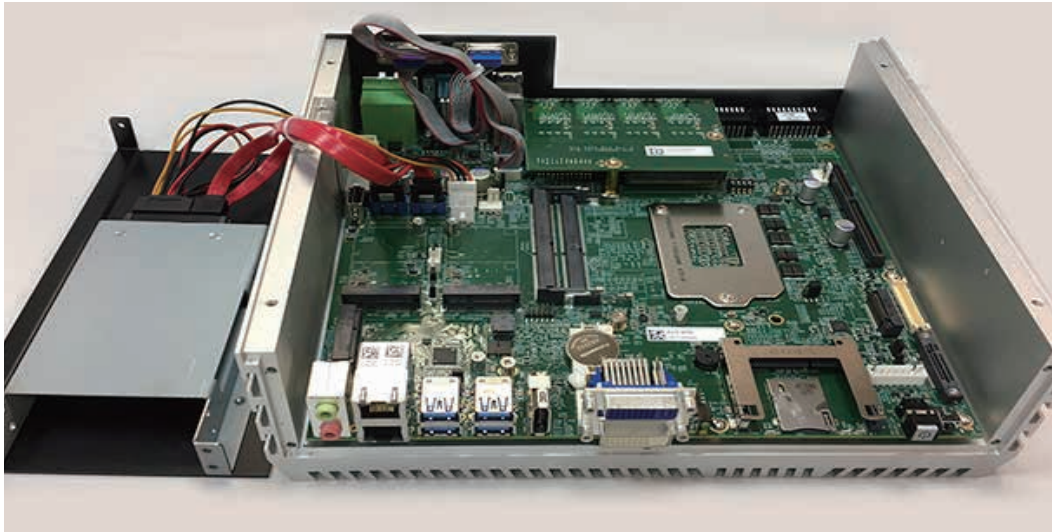

**Step 10** Be careful pull out SATA (yellow) , SATA Power (blue) and COM cable (red) .

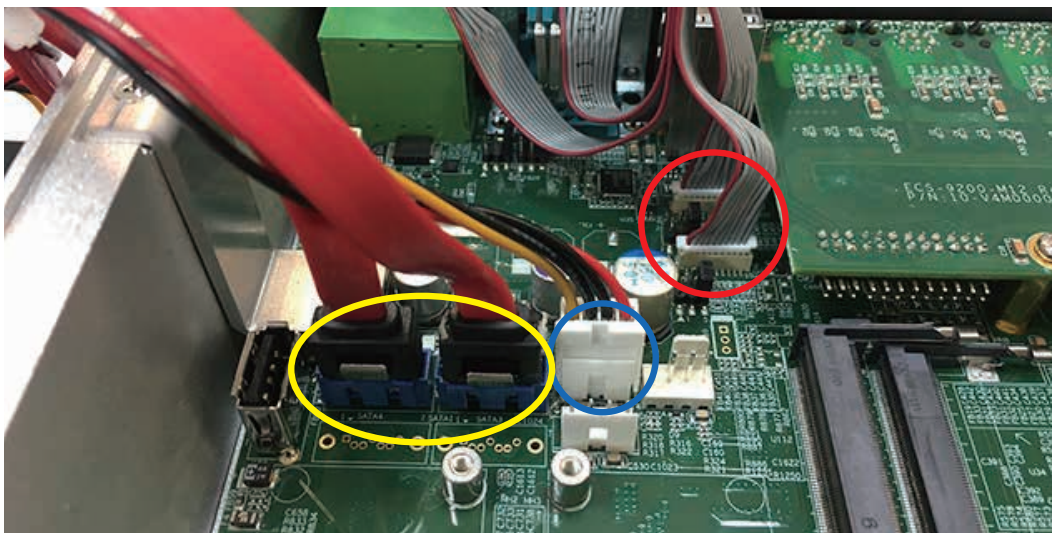

**Step 11** Remove four KHS-#6-32 screws at rear panel.

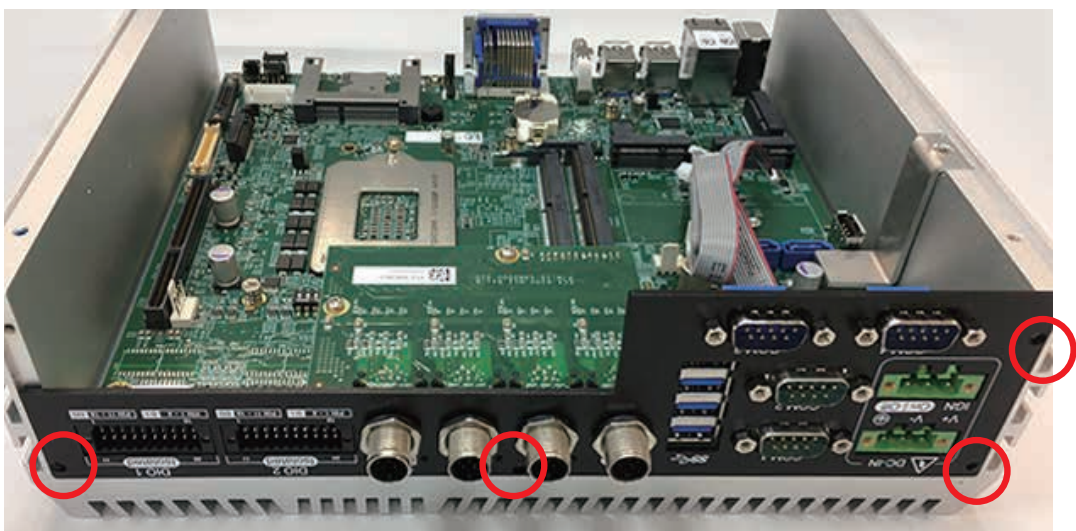

**Step 12** Finish.

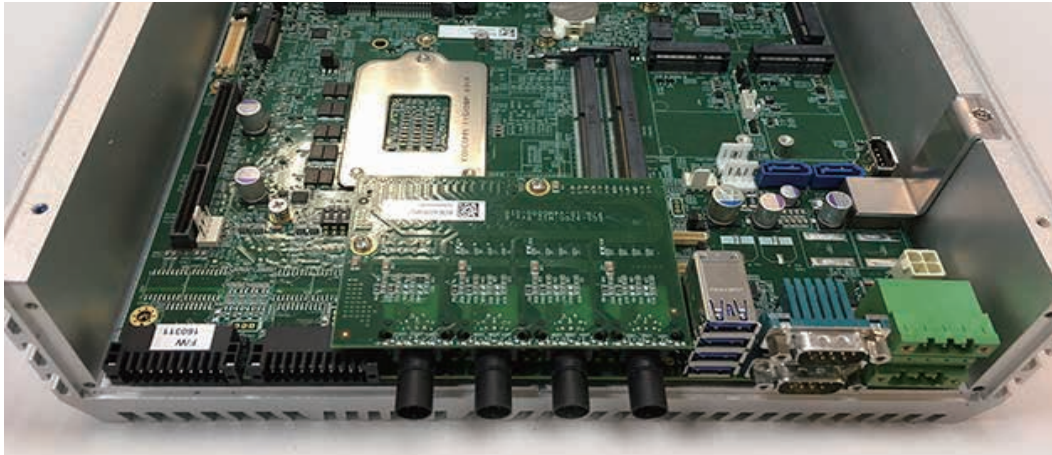

## 3.2 Installing CPU

**Step 1** Remove one F #6-32 and pick up chock bracket.

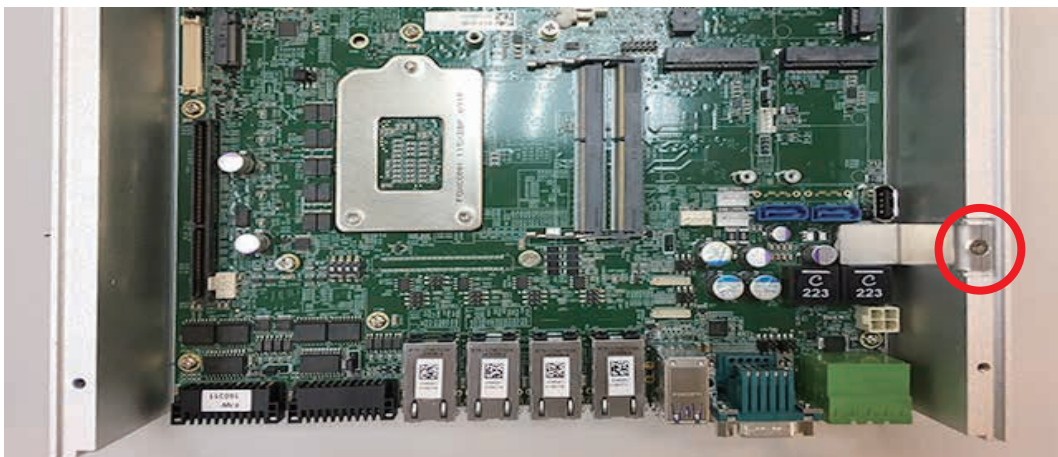

**Step 2** Remove eight PH-M3 and four M3x11 spring screws and pick up mother board.

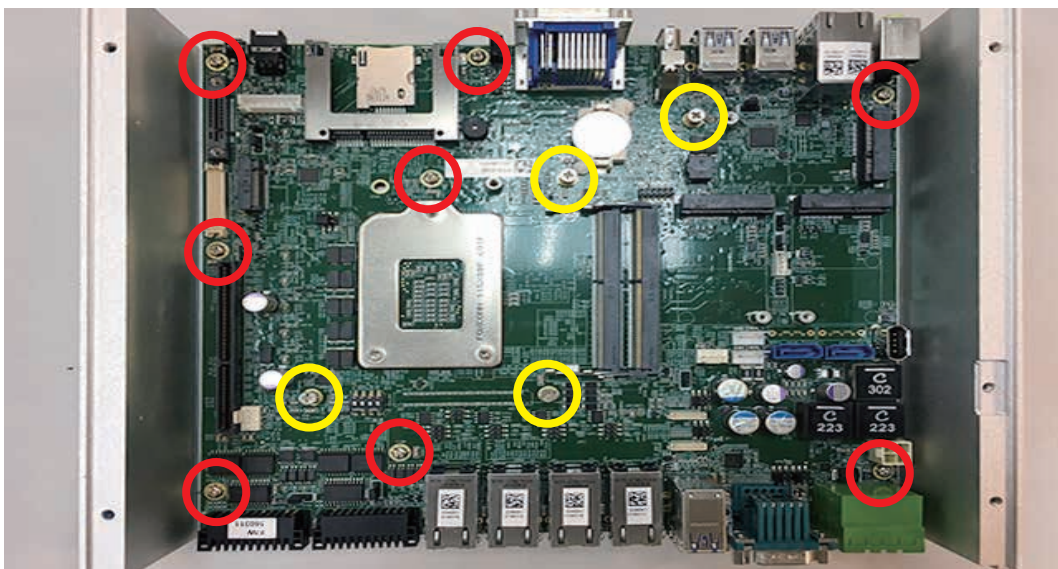

**Step 3** CPU slot.

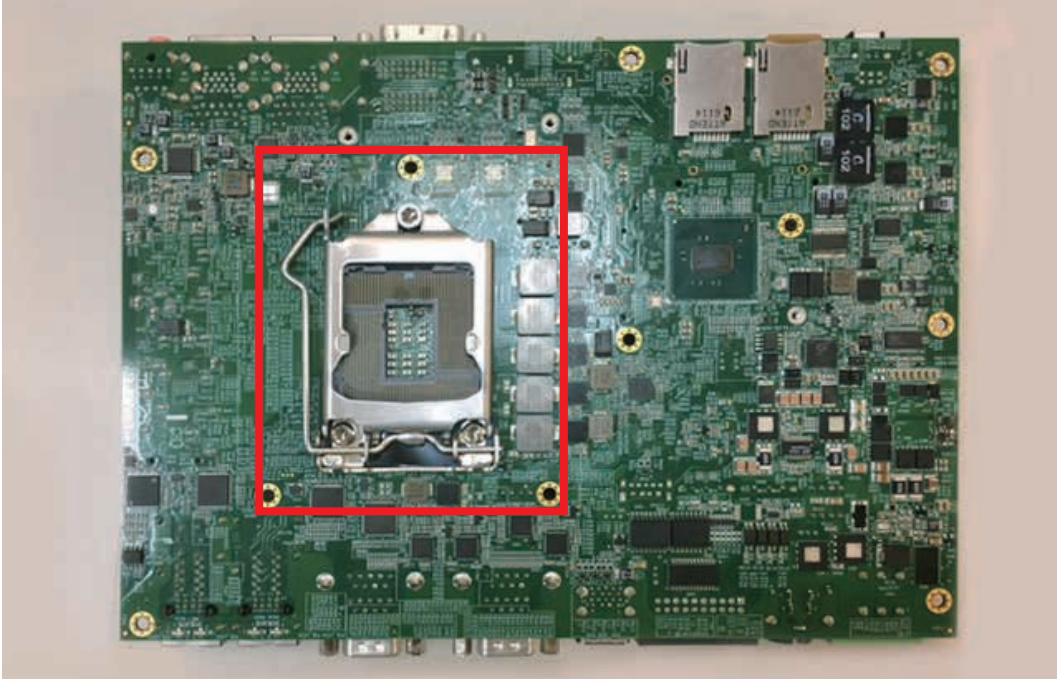

**Step 4** Open CPU slot. (Be careful CPU pins)



**Step 5** Install CPU on the slot.

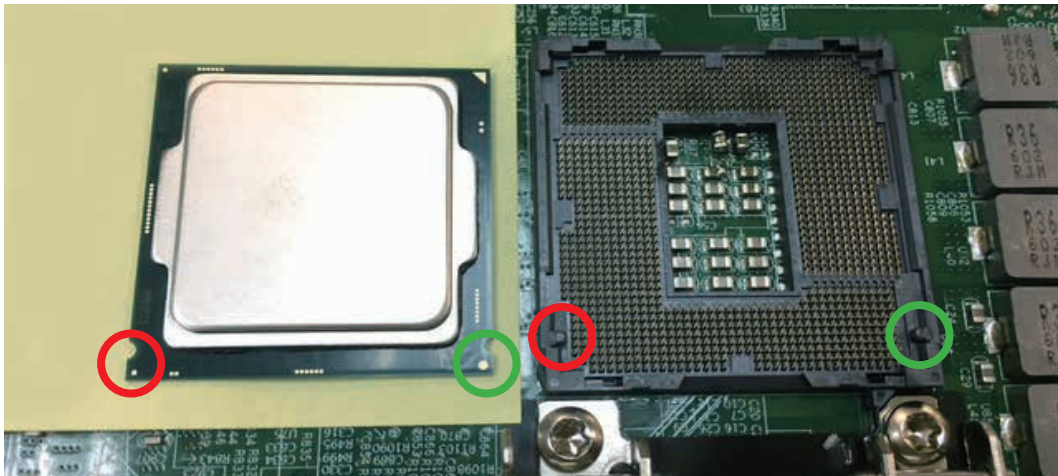

**Step 6** Finish.



**Step 7** Close CPU slot and finish.



### 3.3 Installing DDR4 SO-DIMM Modules

**Step 1** Install DDR4 RAM module into SO-DIMM slot.



**Step 2** Make sure the RAM module is locked by the memory slot.

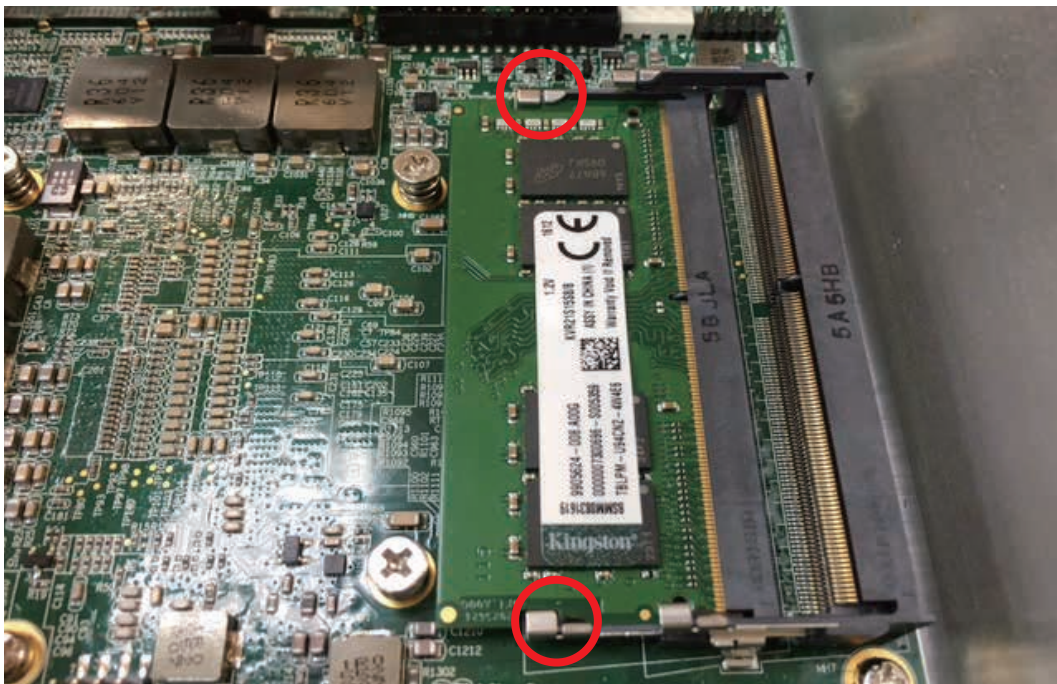

## 3.4 Installing Mini PCIe Card

**Step 1** Install Mini PCIe card into the Mini PCIe socket.



**Step 2** Fasten one M2.5 screw.



### 3.5 Installing CFast Card

**Step 1** Remove 2 pcs F-M3x4 screws on CFast & SIM Card.



**Step 2** Before Inserting CFast & SIM Card, make sure ECS-9200 power is not plugged.

**Step 3** Insert CFast card and push to lock.

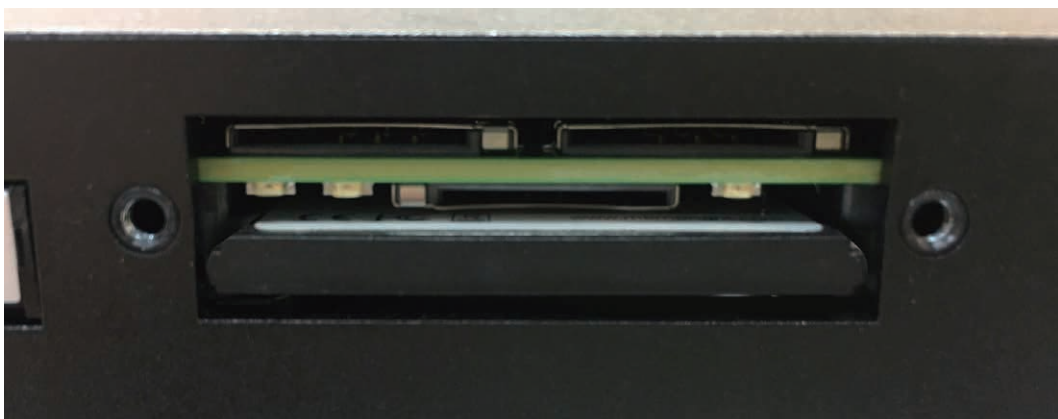
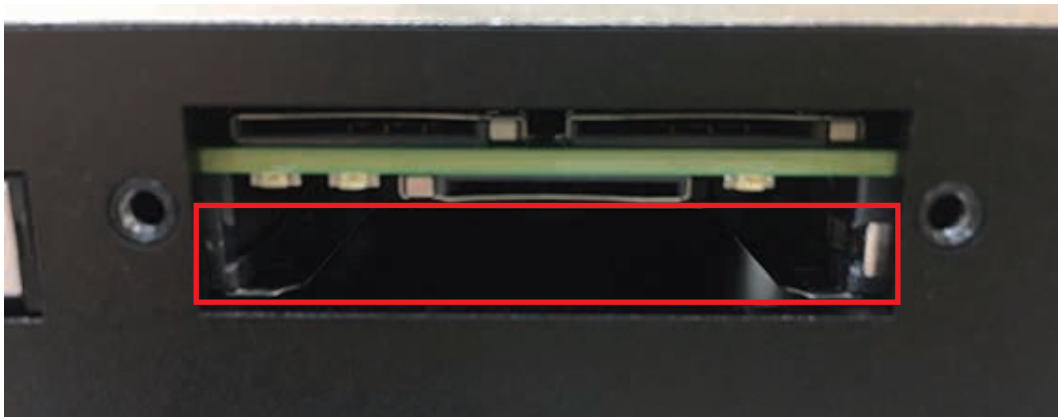



## 3.6 Installing SIM Card

**Step 1** Remove two F-M3x4 screws on CFast & SIM cover.



**Step 2** Before Inserting SIM Card, make sure the system power is not plugged.

**Step 3** Insert SIM card and push to lock.

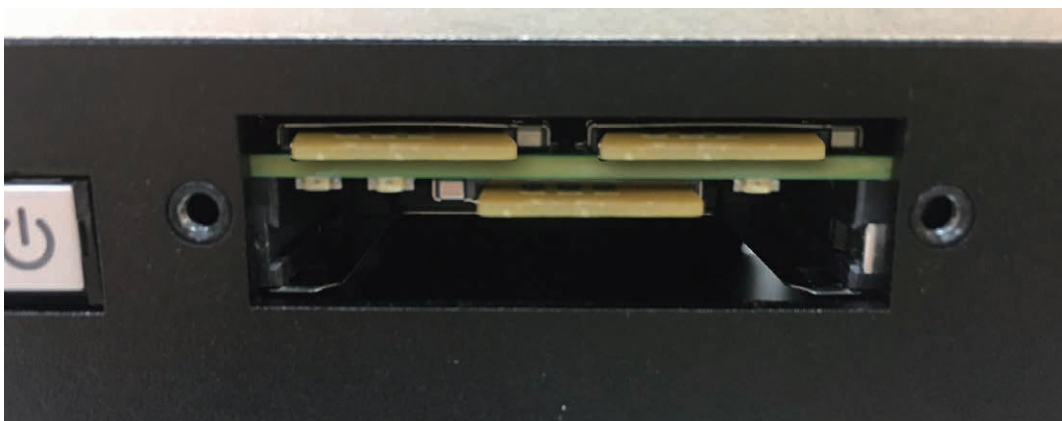
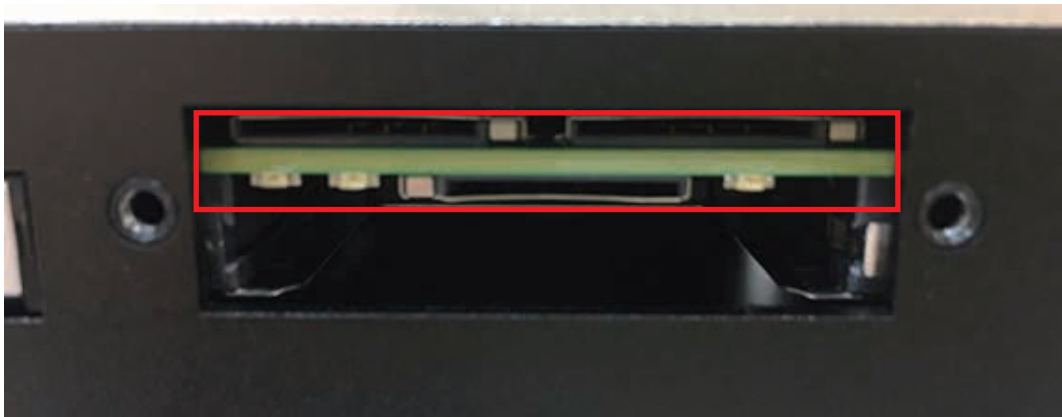

## 3.7 Installing PCI/PCIe Card

**Step 1** Remove the M3 screw.



**Step 2** Remove the bracket.



**Step 3** Install PCI/PCIe card.



**Step 4** Fasten M3 screw.



## 3.8 Installing SSD/HDD

**Step 1** Trigger and open SSD/HDD tray.



**Step 2** Insert 2.5" SSD/HDD in the tray and fasten two F-M3x4 screws.

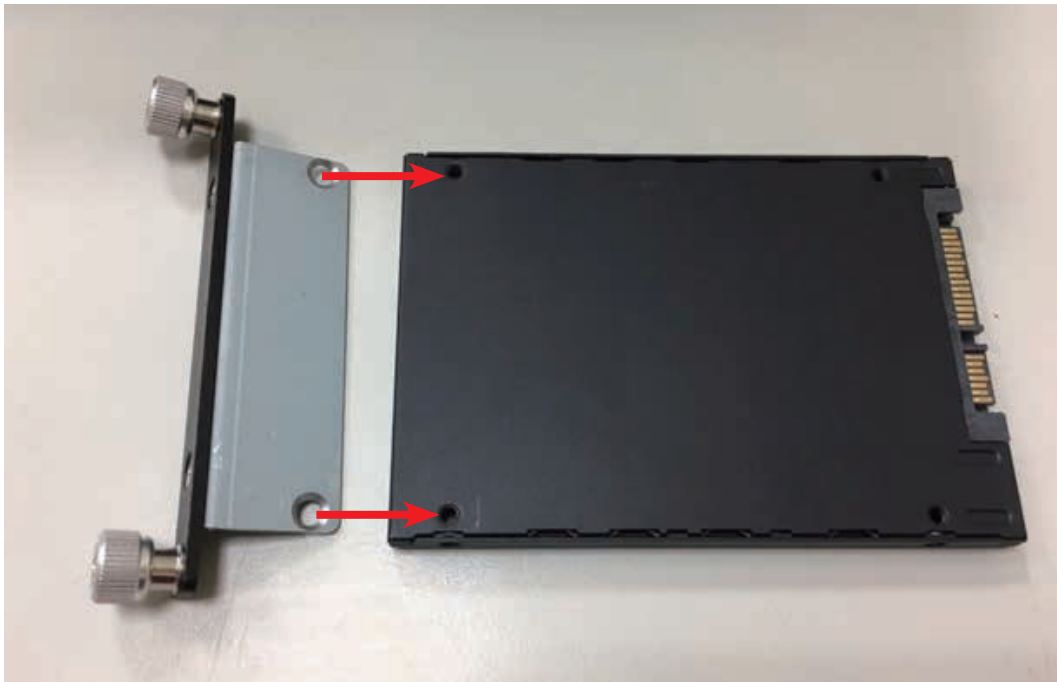

**Step 3** Finish.



**Step 4** Install SSD/HDD.



## 3.9 Installing M.2

Step 1 M.2 slot.

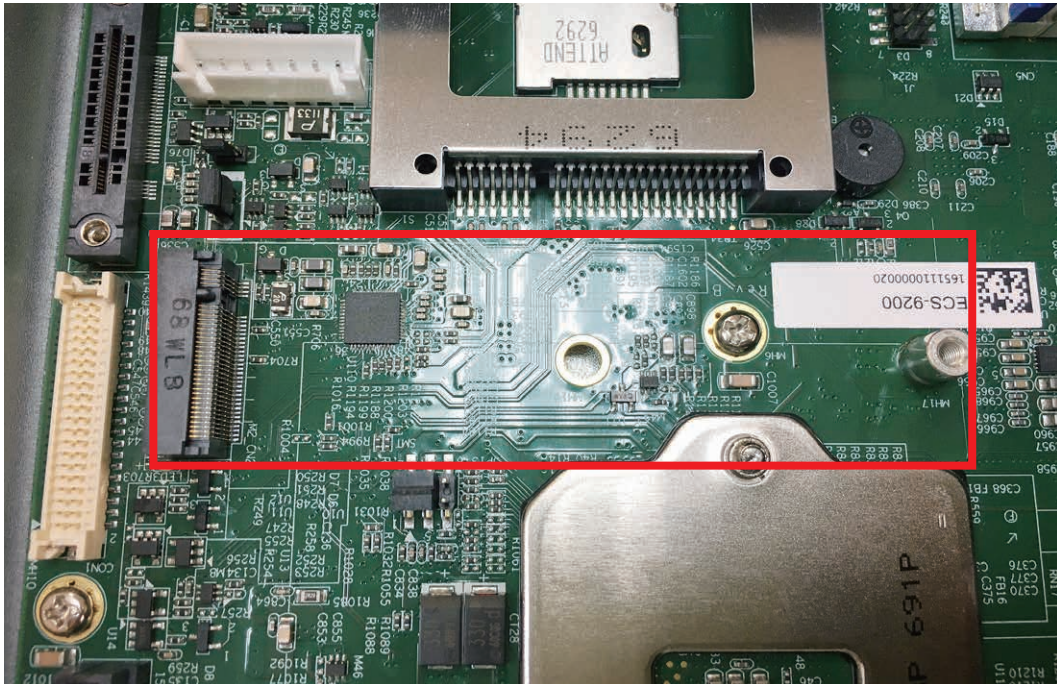

Step 2 Fasten one M3 screws.



## 3.10 Mounting Your ECS-9200/9100

### 3.10.1 Wall Mount Bracket

**Step 1** Ensure the screw holes on the right and left side of the upper case match the ones on ECS-9200/9100 wall mount bracket.

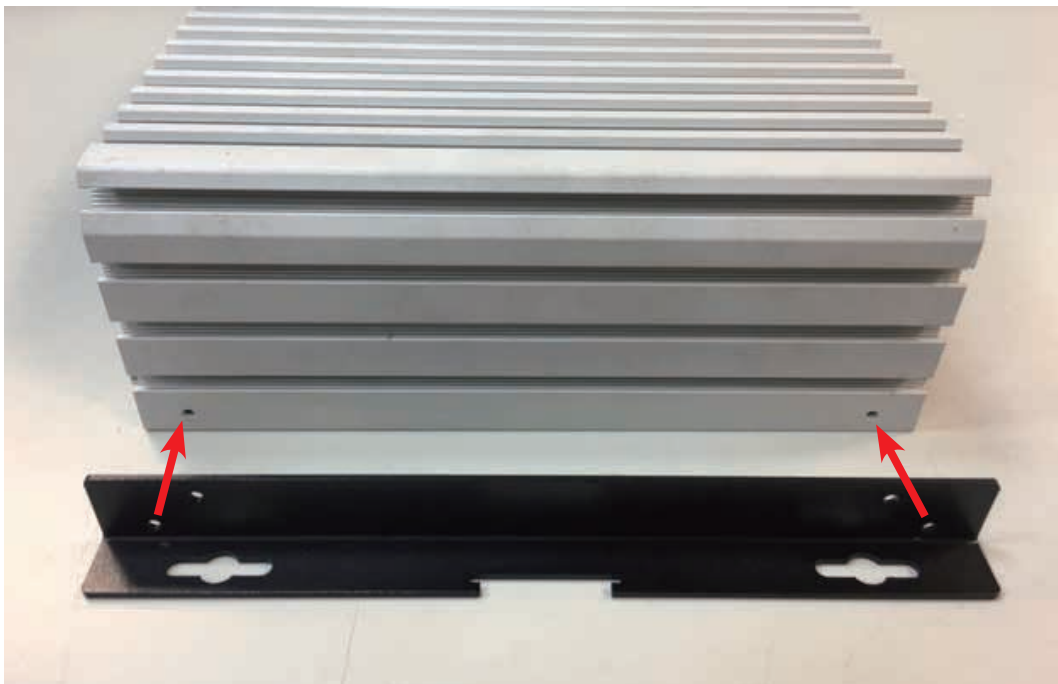

**Step 2** Fasten 4pcs KHS#6-32 screws then finish.

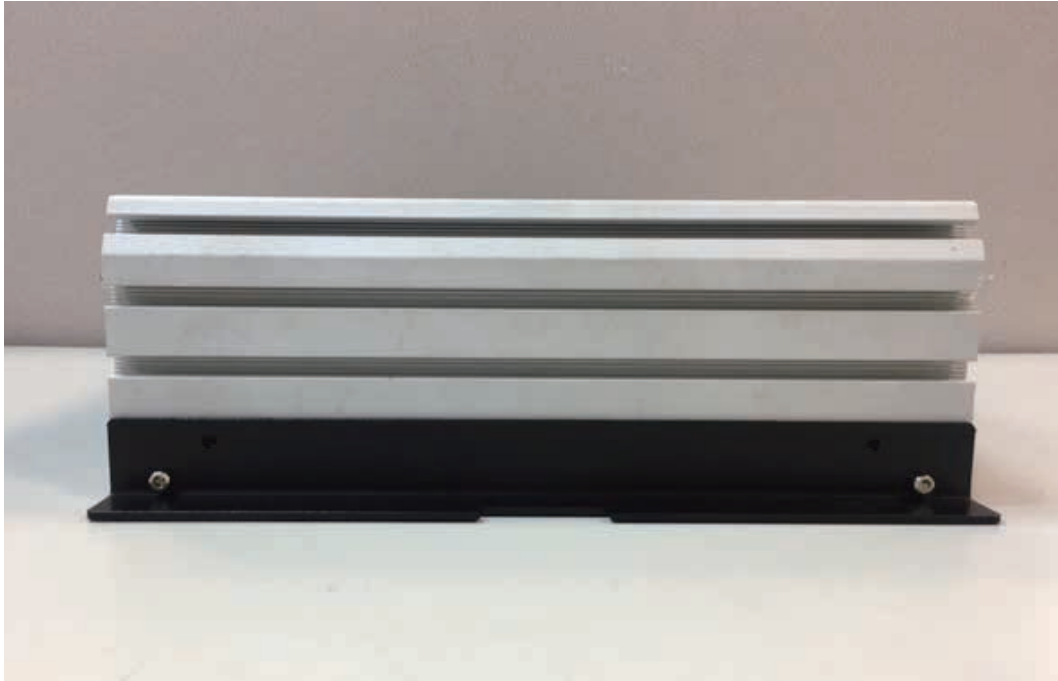



### 3.10.2 VESA Mount

**Step 1** ECS-9200/9100 and VESA Mount.

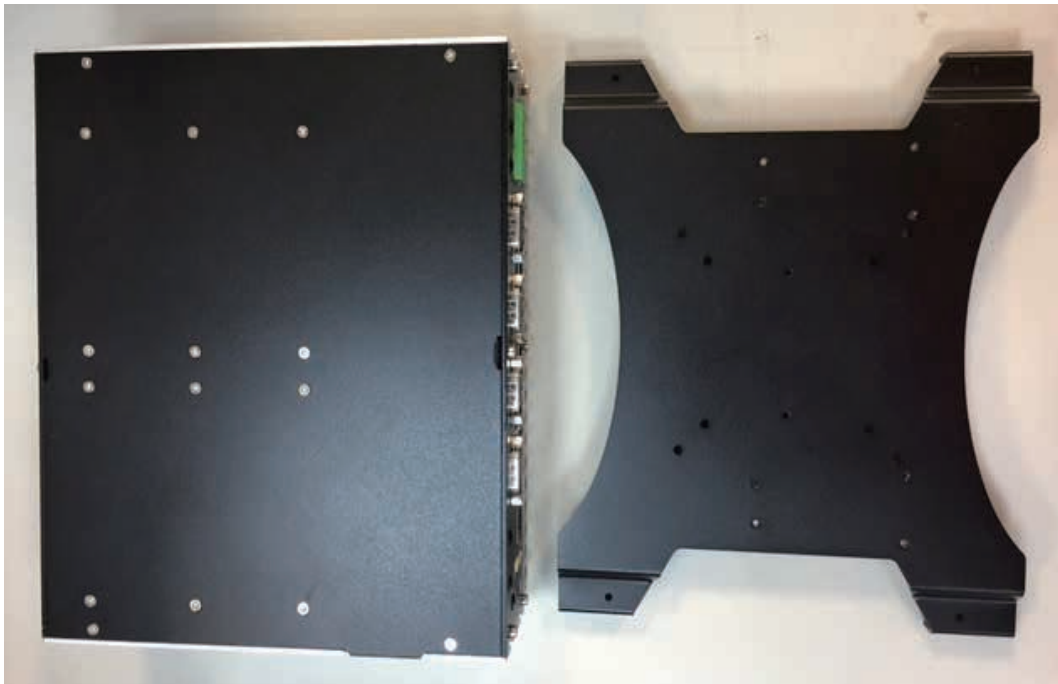

**Step 2** Take ECS-9200/9100 and VESA Mount with fasten 4pcs KHS#6-32 screws.



**Step 3** Fasten four KHS#6-32 screws and then finish.

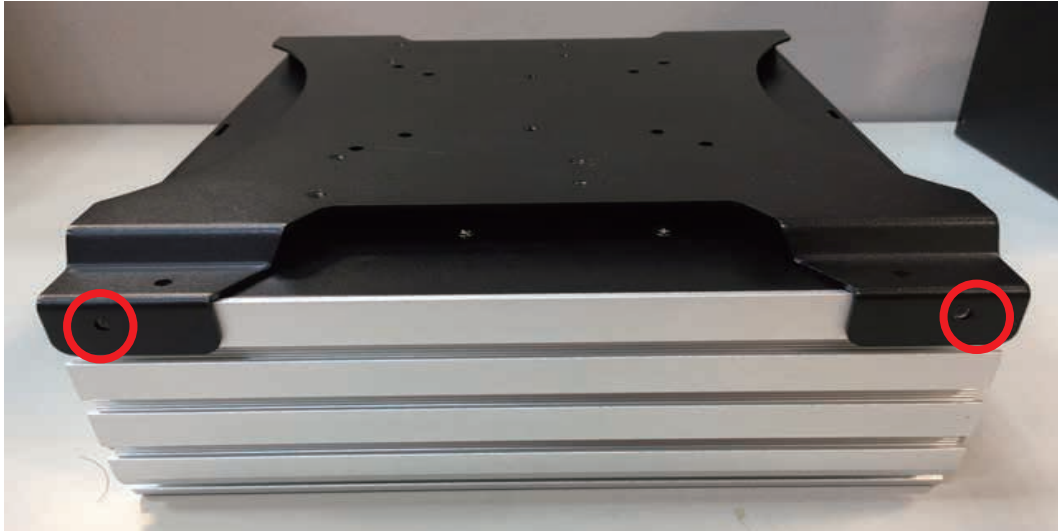

**Step 4** Finish.

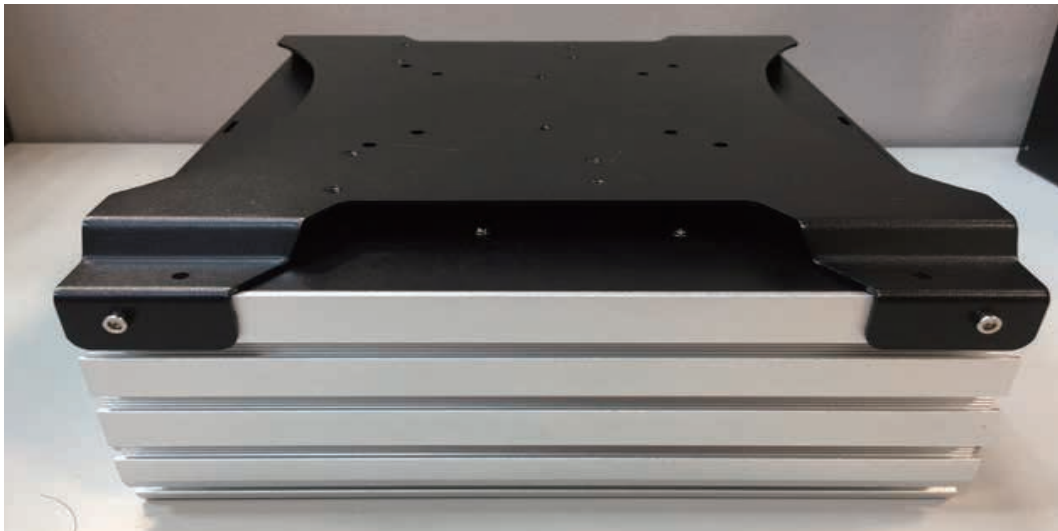

**Step 5** VESA size have 75x75mm(red) and 100x100mm(yellow).

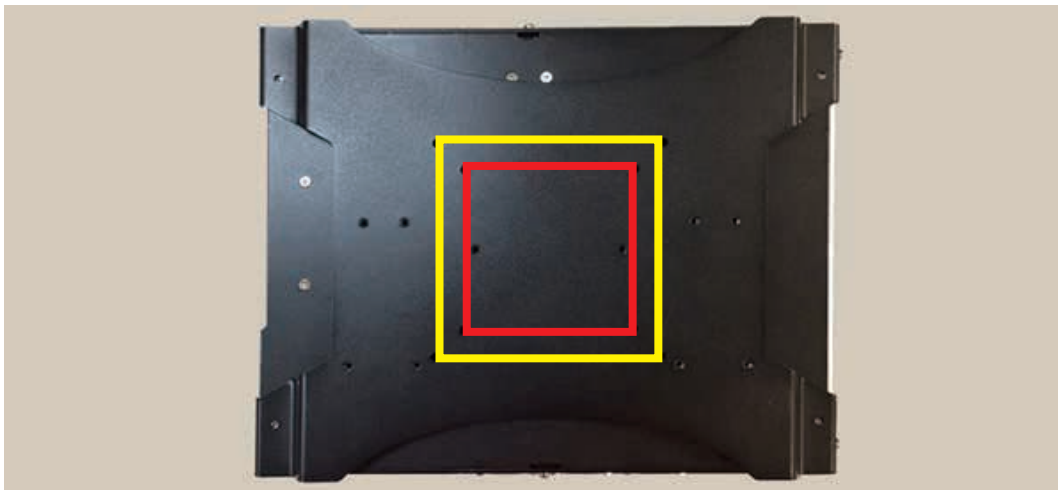

### 3.10.3 Din Rail Kit

**Step 1** ECS-9200/9100 and Din Rail Kit.



**Step 2** Take ECS-9200/9100 and Din Rail Kit and fasten four KHS#6-32 screws in the four marked corners.



**Step 3** Fasten four KHS#6-32 screws and then finish.



**Step 4** Finish.



**Step 5** ECS-9200/9100 With Din Rail.



# 4

## BIOS SETUP

### 4.1 Entering BIOS SETUP

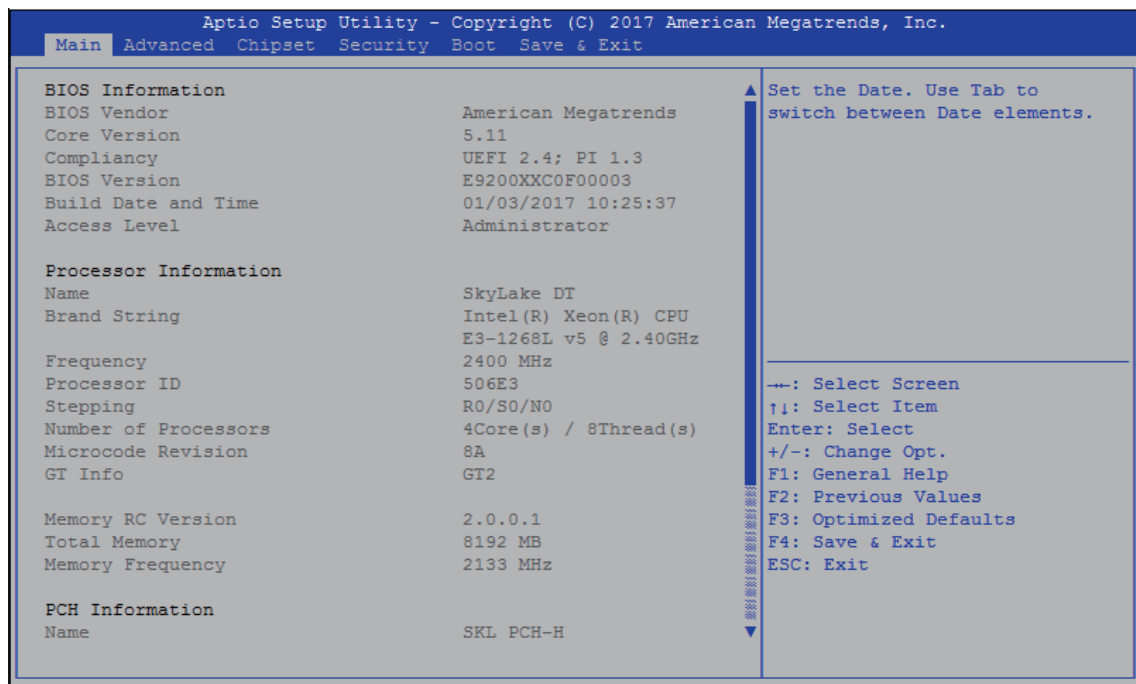

Figure 4-1: Entering Setup Screen

BIOS provides an interface for users to check and change system configuration. The BIOS setup program is accessed by pressing the <Del> key when POST display output is shown.

## 4.2 Main

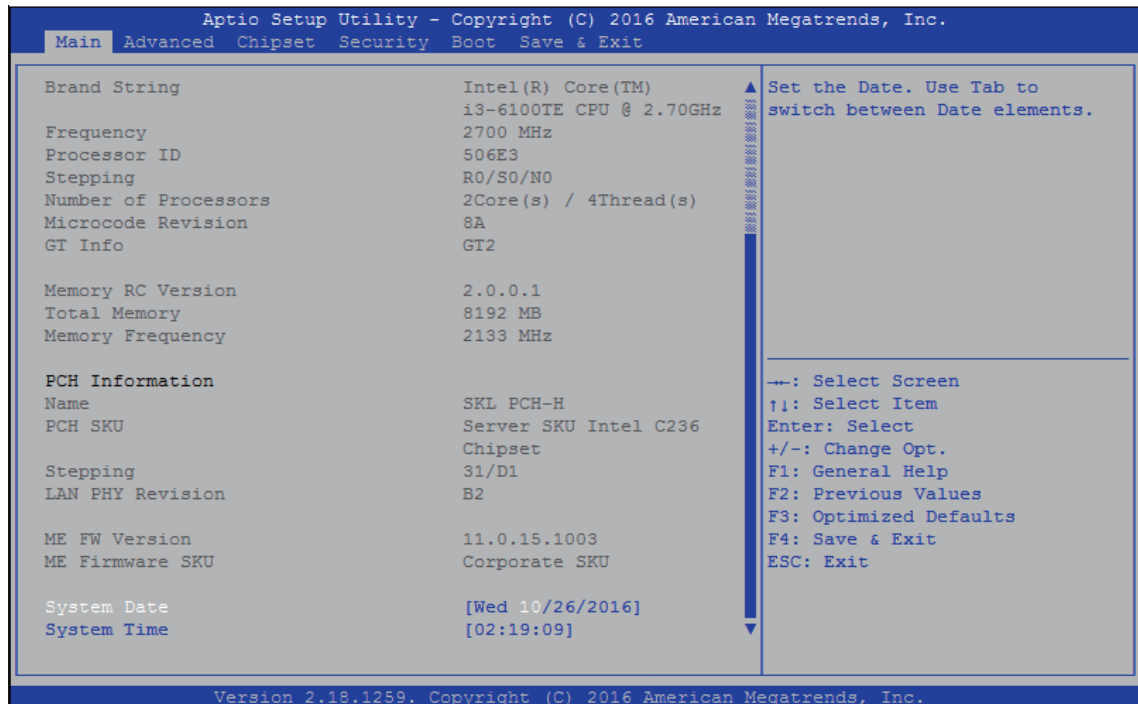

Figure 4-2: BIOS Main Menu

The main menu displays BIOS version and system information. There are two options on Main menu, system date and system time.

### System Date

Set the date. Use <Tab> to switch between date elements.

### System Time

Set the time. Use <Tab> to switch between time elements.

## 4.3 Advanced

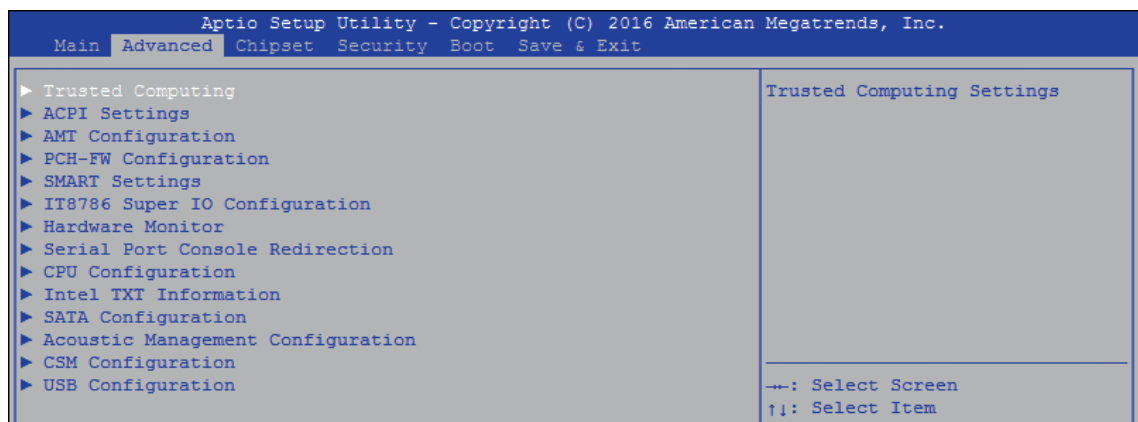

Figure 4 3: BIOS Advanced Menu

Select advanced tab to enter advanced BIOS setup options such as CPU configuration, SATA configuration, and USB configuration.

### 4.3.1 ACPI Settings

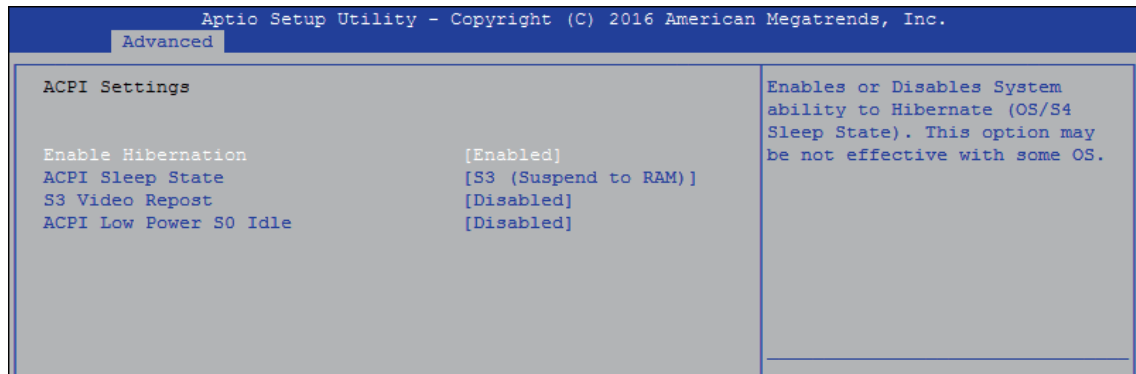

Figure 4 3-1: ACPI Settings

#### Enable Hibernation

Enables or disables system's ability to hibernate (OS/S4 sleep state). This option may not be effective with some OS.

#### ACPI Sleep State

Selects the highest ACPI sleep state the system will enter when the SUSPEND button is pressed.

#### S3 Video Repost

Enables or disables S3 video repost.

#### ACPI Low Power S0 Idle

Enables or disables ACPI low power S0 idle support.

### 4.3.2 AMT Configuration

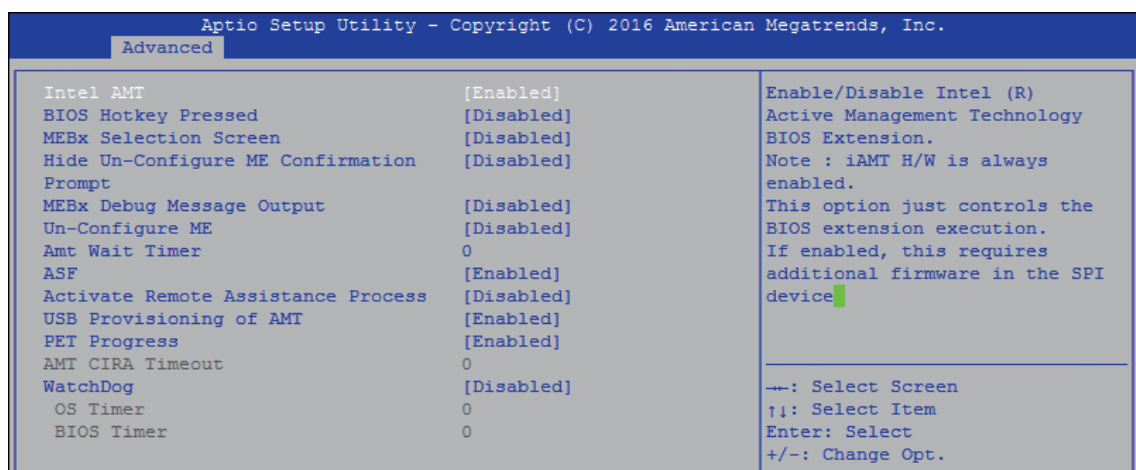

Figure 4 3-2: Intel AMT Settings

#### Intel AMT

Enables/disables Intel (R) Active Management Technology BIOS extension. Note: iAMT H/W is always enabled. This option just controls the BIOS extension execution. If enabled, this requires additional firmware in the SPI device.

### 4.3.3 PCH-FW Configuration

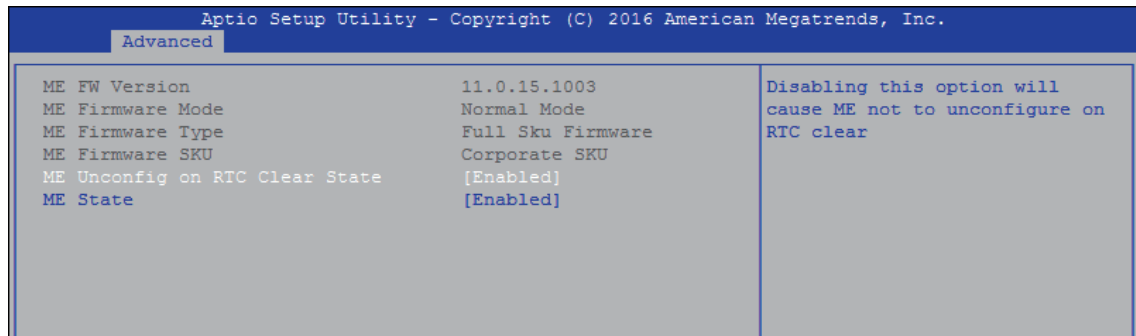

Figure 4 3-3: PCH-FW Settings

#### ME Unconfig on RTC Clear State

Disabling this option will cause ME not to unconfigure on RTC clear.

#### ME State

Set ME to Soft temporarily disabled.

### 4.3.4 SMART Settings

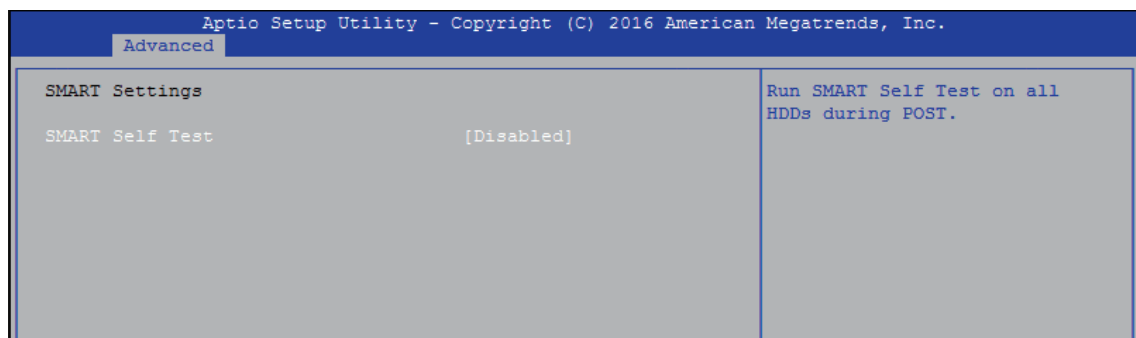

Figure 4 3-4: SMART Settings

#### SMART Self Test

Run SMART self test on all HDDs during POST.

### 4.3.5 IT8786 Super IO Configuration

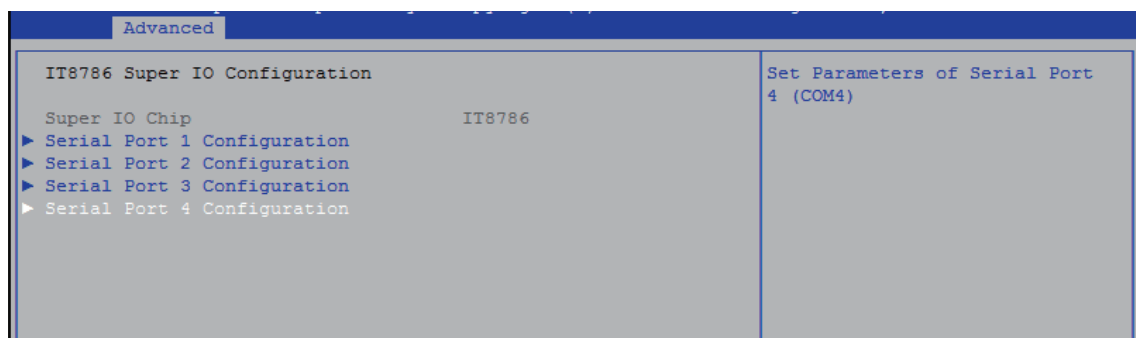

Figure 4-3-5: Super IO Settings



### Serial Port 1 Configuration

Set parameters of serial port 1 (COM 1).

### Serial Port 2 Configuration

Set parameters of serial port 2 (COM 2).

### Serial Port 3 Configuration

Set parameters of serial port 3 (COM 3).

### Serial Port 4 Configuration

Set parameters of serial port 4 (COM 4).

## 4.3.6 Hardware Monitor

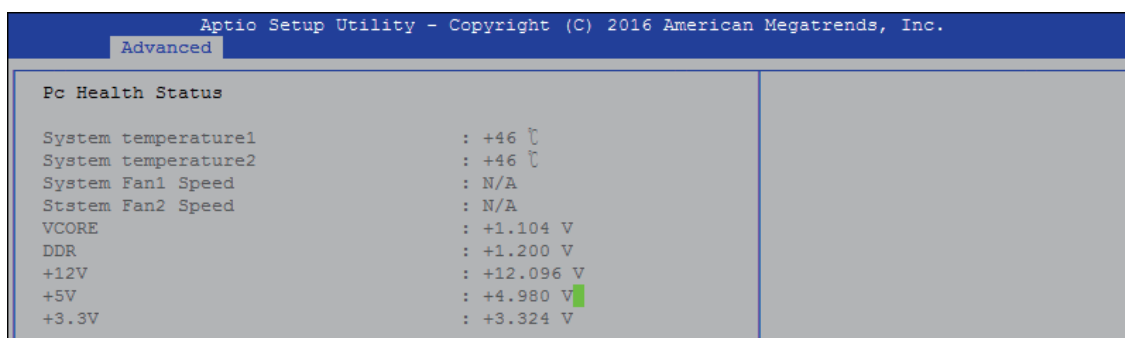

Figure 4 3-6: Hardware Monitor Settings

The IT8786 SIO features an enhanced hardware monitor providing thermal, fan speed, and system voltages' status monitoring.

## 4.3.7 Serial Port Console Redirection



Figure 4 3-7: Serial Port Console Redirection Settings

### Console Redirection

Console redirection enable or disable.

### Console Redirection Settings

The settings specify how the host computer and the remote computer (which the user is using) will exchange data. Both computers should have the same or compatible settings.

## 4.3.8 CPU Configuration

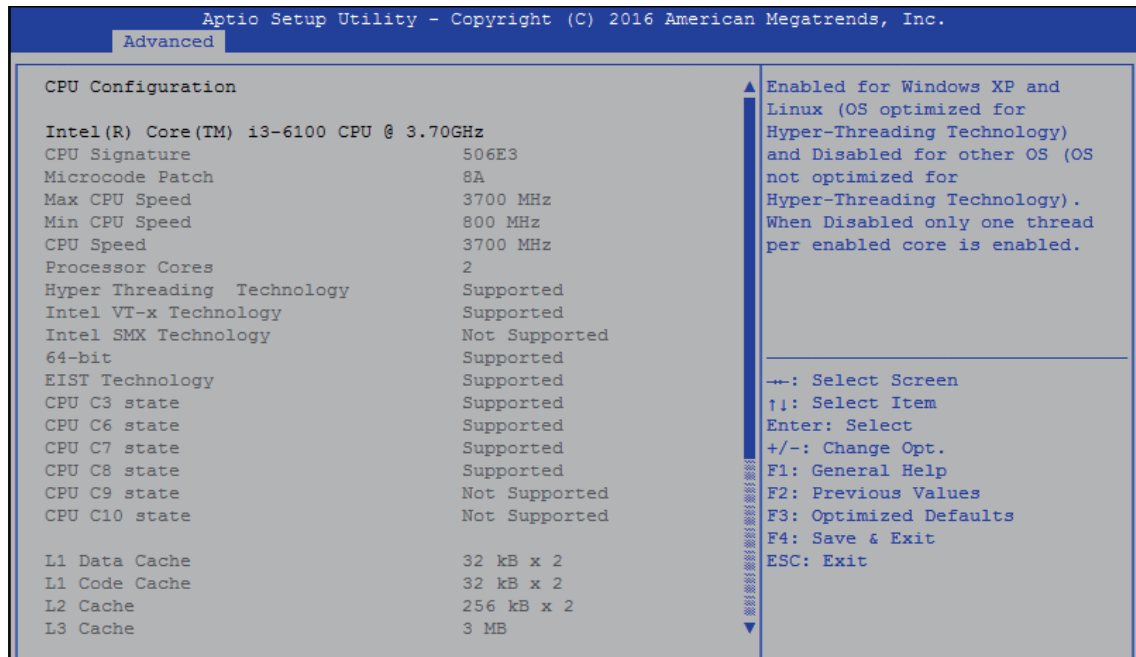

Figure 4 3-8: CPU Function Settings

### Hyper-threading

Enabled for Windows XP and Linux (OS optimized for Hyper-Threading Technology) and disabled for other OS (OS not optimized for Hyper-Threading Technology). When disabled, only one thread per core is enabled.

### Active Processor Cores

Number of cores to enable in each processor package.

### Intel Virtualization Technology

When enabled, a VMM can utilize the additional hardware capabilities provided by Vanderpool Technology.

### Hardware Prefetcher

To turn on/off the MLC streamer prefetcher.

### Adjacent Cache Line Prefetch

To turn on/off prefetching of adjacent cache lines.

### CPU AES

Enable/disable CPU Advanced Encryption Standard instructions.

### Boot performance mode

Select the performance state that the BIOS will set before OS handoff.

### Intel(R) SpeedStep(tm)

Allows more than two frequency ranges to be supported.

### Turbo Mode

Turbo Mode.

### CPU C state

Enable or disable CPU C states.

### Enhanced C-states

Enable/disable C1E. When enabled, CPU will switch to minimum speed when all cores enter C-State.

### Package C State limit

Package C State limit.

### Intel TXT(LT) Support

Enables or disables Intel (R) TXT (LT) support.

## 4.3.9 Intel TXT Information

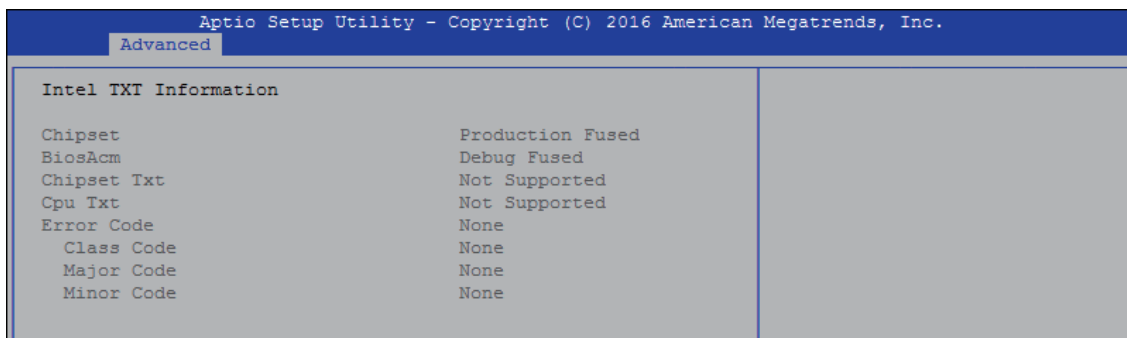

Figure 4 3-9: Intel TXT Information

Display Intel TXT information.

## 4.3.10 SATA Configuration

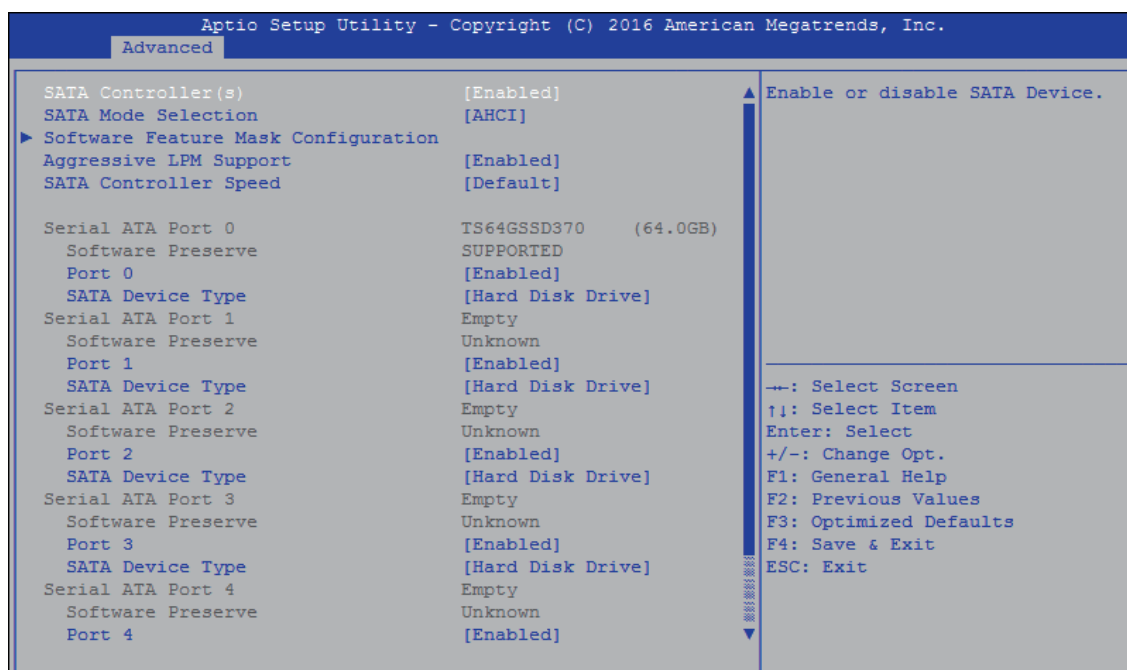

Figure 4 3-10: SATA Devices Settings

### SATA Controller(s)

Enable or disable SATA Device.

### SATA Mode Selection

Determines how SATA controller(s) operate.

### Software Feature Mask Configuration

RAID OROM/RST driver will refer to the SWFM configuration to enable or disable the storage features.

### Aggressive LPM Support

Enable PCH to aggressively enter link power state.

### SATA Controller Speed

Indicates the maximum speed the SATA controller can support.

### Options for each SATA port:

Port 0

Enable or disable SATA Port.

### Spin Up Device

On an edge detect from 0 to 1, the PCH starts a COMRESET initialization sequence to the device.

### SATA Device Type

Identifies that the SATA port is connected to solid state drive or hard disk drive.

## 4.3.10 Acoustic Management Configuration

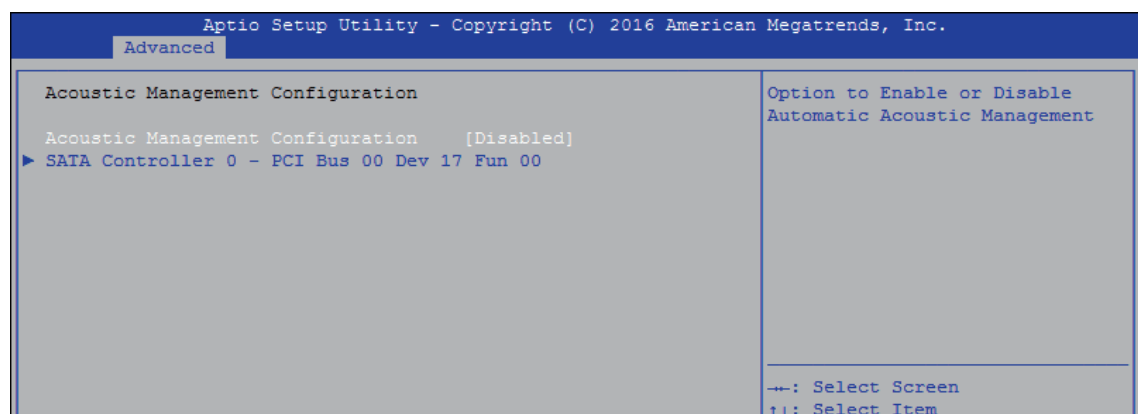

Figure 4 3-11: Acoustic Management Settings

### Acoustic Management Configuration

Option to enable or disable automatic acoustic management.

## 4.3.12 CSM Configuration

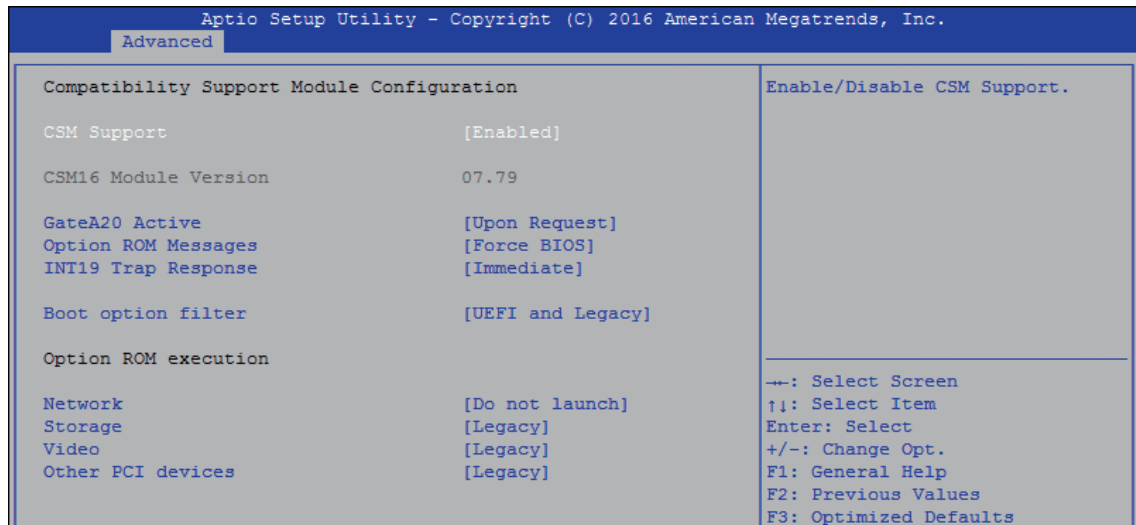

Figure 4 3-12: CSM Settings

### CSM Support

Enable/disable CSM support

### GateA20 Active

UPON REQUEST - GA20 can be disabled using BIOS services.

ALWAYS - do not allow GA20 to be disabled; this option is useful when any RT code is executed above 1MB.

### Option ROM Messages

Set display mode for Option ROM.

### INT19 Trap Response

BIOS reaction on INT19 trapping by Option ROM:

IMMEDIATE - execute the trap right away;

POSTPONED - execute the trap during legacy boot.

### Boot option filter

This option controls Legacy/UEFI ROM's priority.

### Network

Controls the execution of UEFI and Legacy PXE OpROM.

### Storage

Controls the execution of UEFI and Legacy Storage OpROM.

### Video

Allows more than two frequency ranges to be supported.

### Other PCI devices

Determines OpROM execution policy for devices other than network, storage, or video.

### 4.3.13 USB Configuration

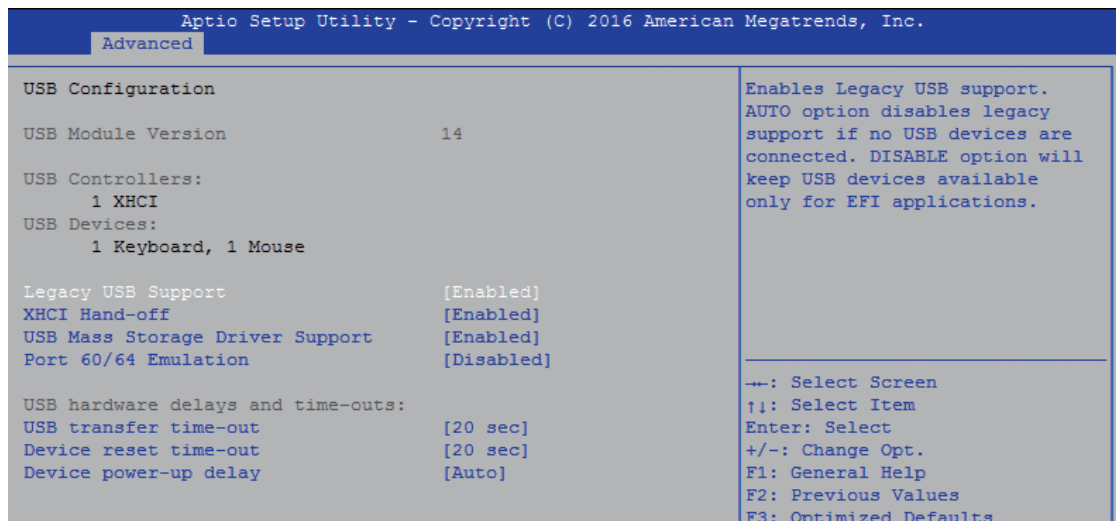

Figure 4 3-13: USB Settings

#### Legacy USB Support

Enables Legacy USB support.

AUTO option disables Legacy support if no USB devices are connected.

DISABLE option will keep USB devices available only for EFI applications.

#### XHCI Hand-off

This is a workaround for OS-es without XHCI hand-off support. The XHCI ownership change should be claimed by XHCI driver.

#### USB Mass Storage Driver Support

Enable/disable USB mass storage driver support.

#### Port 60/64 Emulation

Enables I/O port 60h/64h emulation support. This should be enabled for the complete USB keyboard legacy support for non-USB aware OS-es.

#### USB transfer time-out

The time-out value for control, bulk, and interrupt transfers.

#### Device reset time-out

USB mass storage device start unit command time-out.

#### Device power-up delay

Maximum time the device will take before it properly reports itself to the Host Controller. 'Auto' uses default value, for a root port it is 100 ms, for a hub port the delay is taken from the hub descriptor.

## 4.4 Chipset

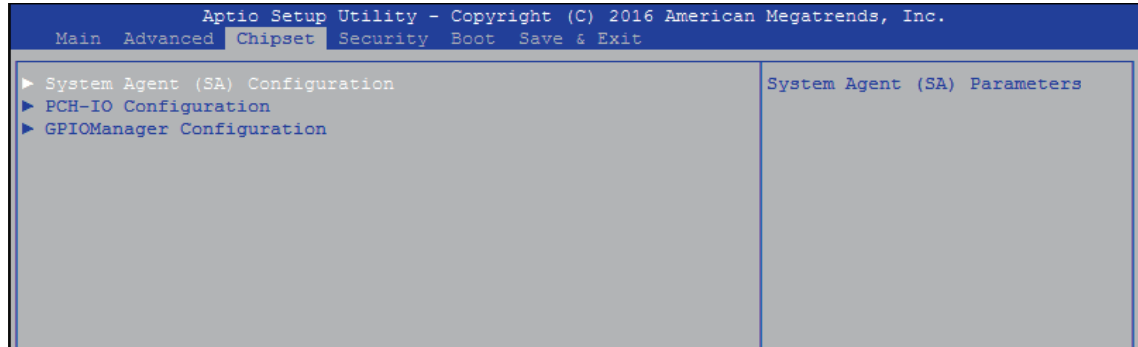

Figure 4-4: BIOS Chipset Menu

### System Agent (SA) Configuration

System Agent (SA) parameters.

### PCH-IO Configuration

PCH parameters.

### GPIOManager Configuration

GPIOManager parameters.

### 4.4.1 System Agent (SA) Configuration

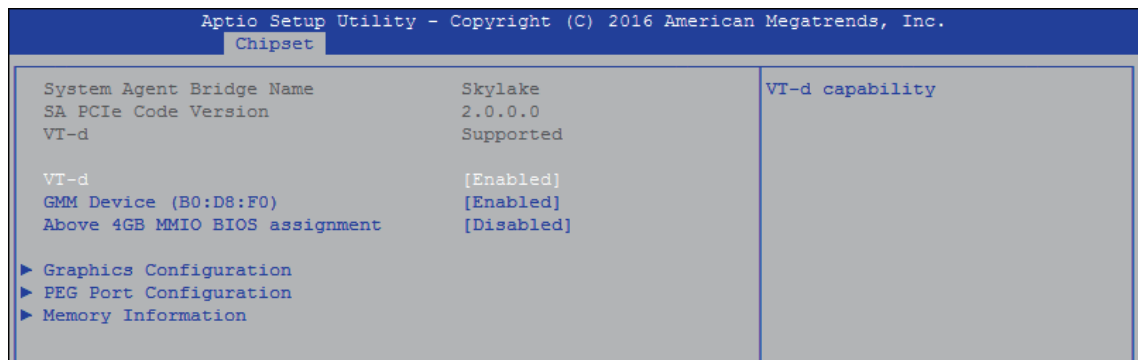

Figure 4-4-1: System Agent Settings

#### VT-d

VT-d capability.

#### GMM Device (B0:D8:F0)

Enable/disable SA GMM device.

#### Above 4GB MMIO BIOS assignment

Enable/disable above 4GB MemoryMappedIO BIOS assignment. This is disabled automatically when aperture size is set to 2048MB.

## 4.4.2 Graphics Configuration of System Agent (SA)

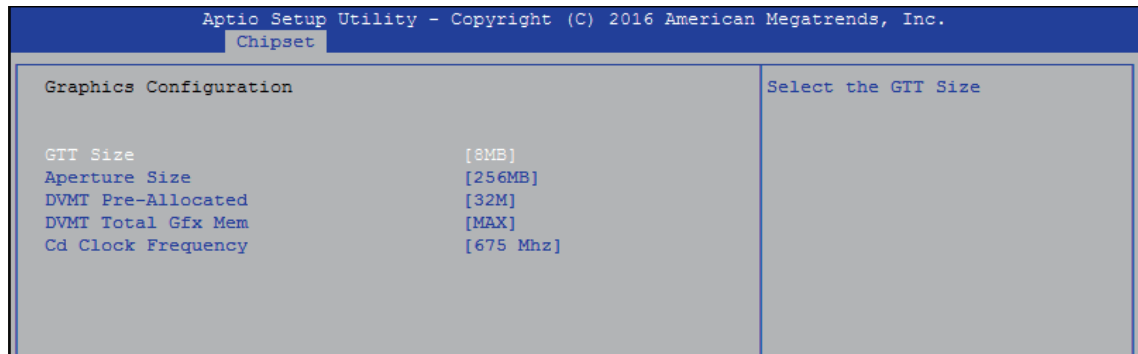

Figure 4-4-2: Graphics Settings

### GTT Size

Select the GTT Size.

### Aperture Size

Select the Aperture Size.

Note: Above 4GB MMIO BIOS assignment is automatically enabled when selecting 2048MB aperture. To use this feature, please disable CSM Support.

### DVMT Pre-Allocated

Select DVMT 5.0 Pre-Allocated (Fixed) Graphics Memory size used by the Internal Graphics Device.

### DVMT Total Gfx Mem

Select DVMT5.0 Total Graphic Memory size used by the Internal Graphics Device.

### Cd Clock Frequency

Select the highest Cd Clock frequency supported by the platform.

## 4.4.3 PEG Port Configuration (SA)

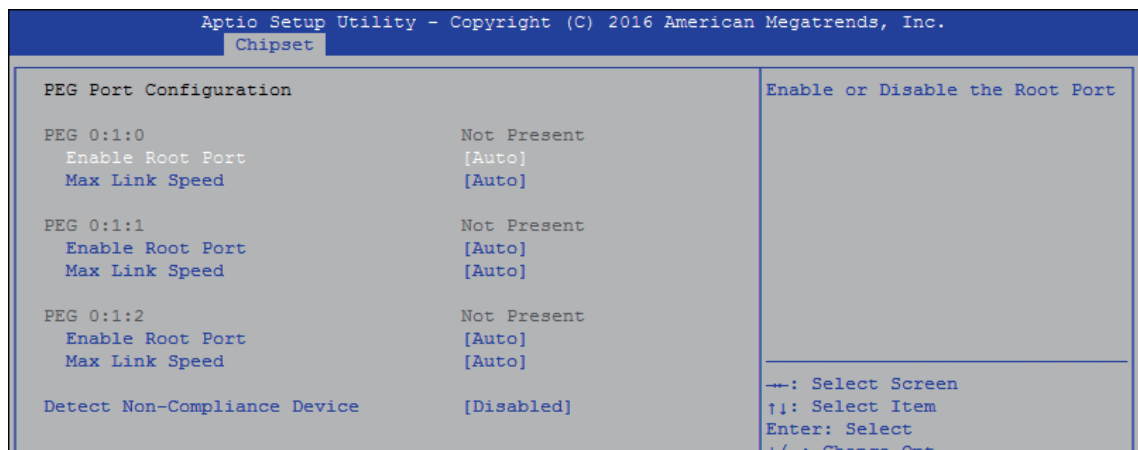

Figure 4-4-3: PEG Port Configuration

PEG port options for PCIe device.



#### 4.4.4 Memory Information of System Agent (SA)

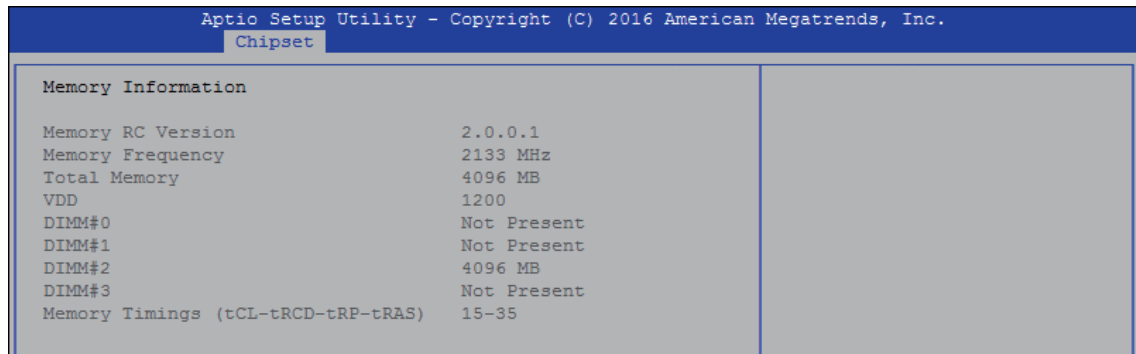

Figure 4-4-4: Memory Information

Displays memory information.

#### 4.4.5 PCH-IO Configuration

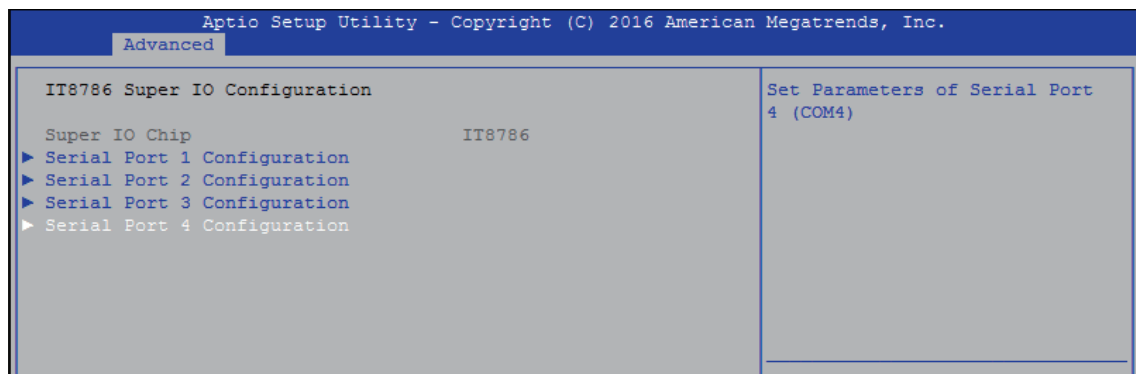

Figure 4-4-5: PCH-IO Settings

##### **PCH LAN Controller**

Enable or disable onboard NIC.

##### **Wake on LAN**

Enable or disable integrated LAN to wake the system. (The wake On LAN cannot be disabled if ME is on at Sx state.)

##### **Serial IRQ Mode**

Configure serial IRQ mode.

##### **State After G3**

Specify what state to go to when power is re-applied after a power failure (G3 state).

S0 State: Always turn-on the system when power source plugged-in.

S5 State: Always turn-off the system when power source plugged-in.

## 4.4.6 PCI Express Configuration of PCH-IO

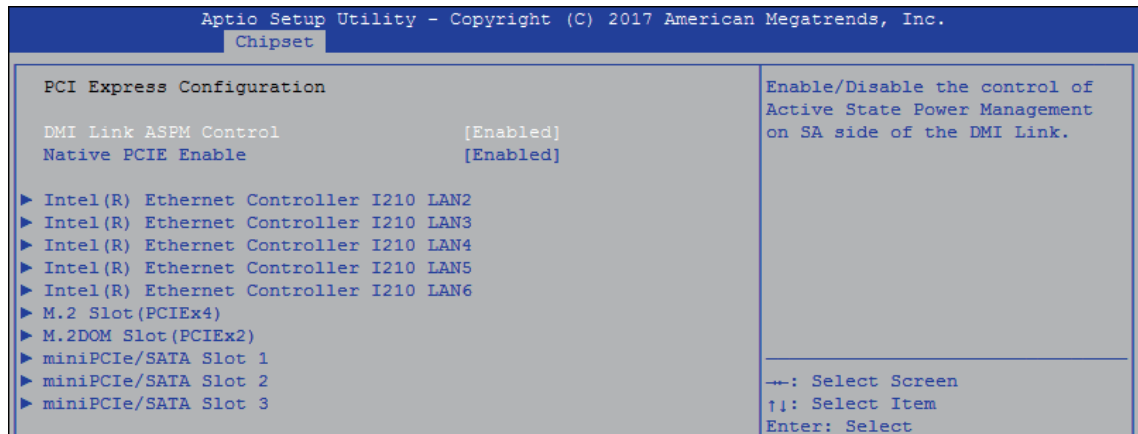

Figure 4-4-6: PCH-IO Settings

### DMI Link ASPM Control

Enable/Disable the control of Active State Power Management on SA side of the DMI Link.

### Native PCIE Enable

PCI Express Native Support Enable/Disable. This feature is available in vista and beyond Windows OS.

## 4.4.7 BIOS Security Configuration of PCH-IO

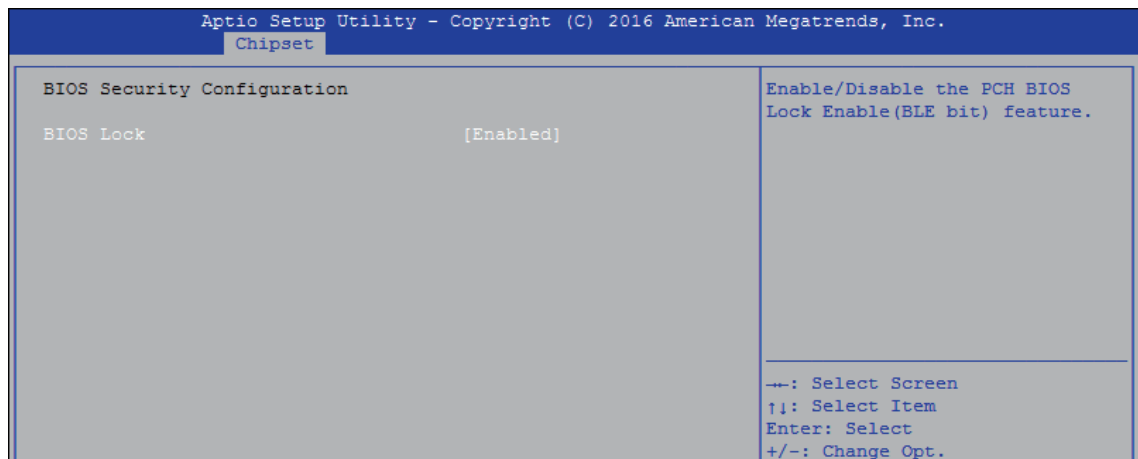

Figure 4-4-7: BIOS Security Settings

### BIOS Lock

Enable/disable the PCH BIOS Lock Enable (BLE bit) feature.

## 4.4.8 SB Porting Configuration of PCH-IO

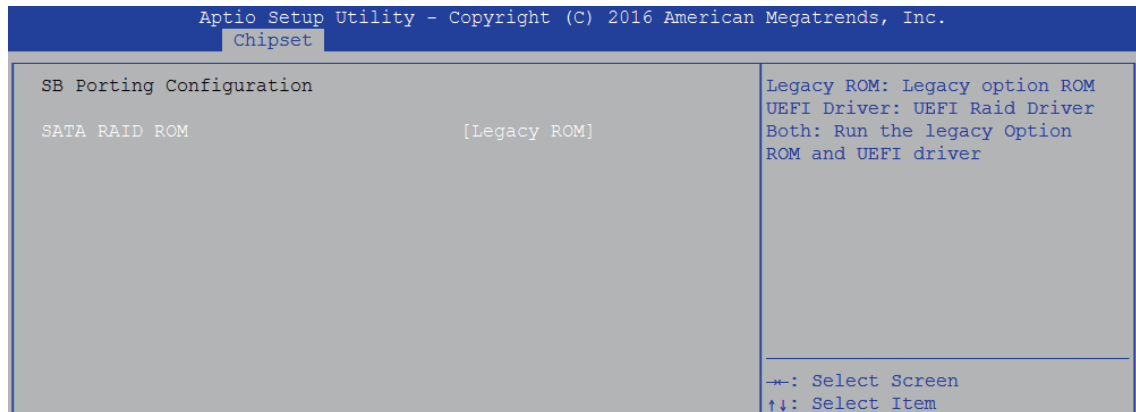

Figure 4-4-8: RAID ROM Settings

### SATA RAID ROM

Legacy ROM: Legacy option ROM

UEFI Driver: UEFI Raid Driver

Both: Run the Legacy Option ROM and UEFI driver.

## 4.4.9 GPIO Manager Configuration

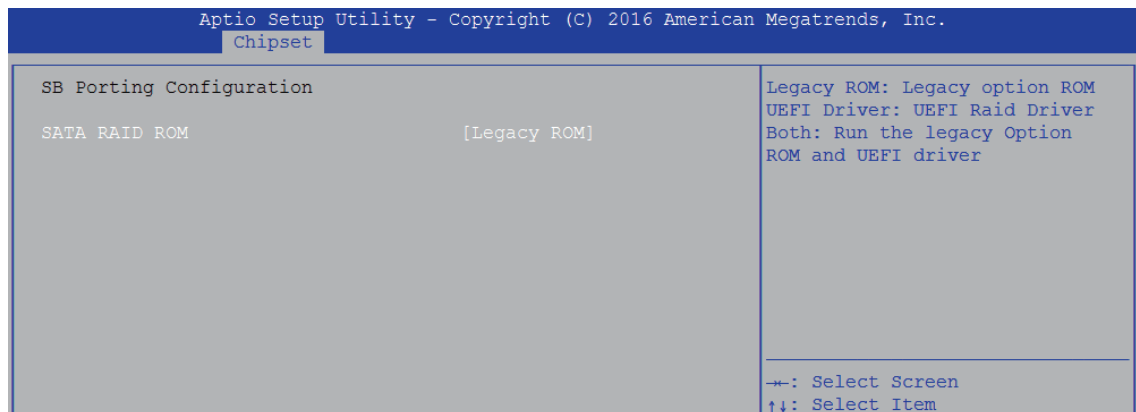

Figure 4-4-9: GPIO Manager Settings

### VGA Enable

Enable: VGA display output enabled

Disable: VGA display output disabled

## 4.5 Security

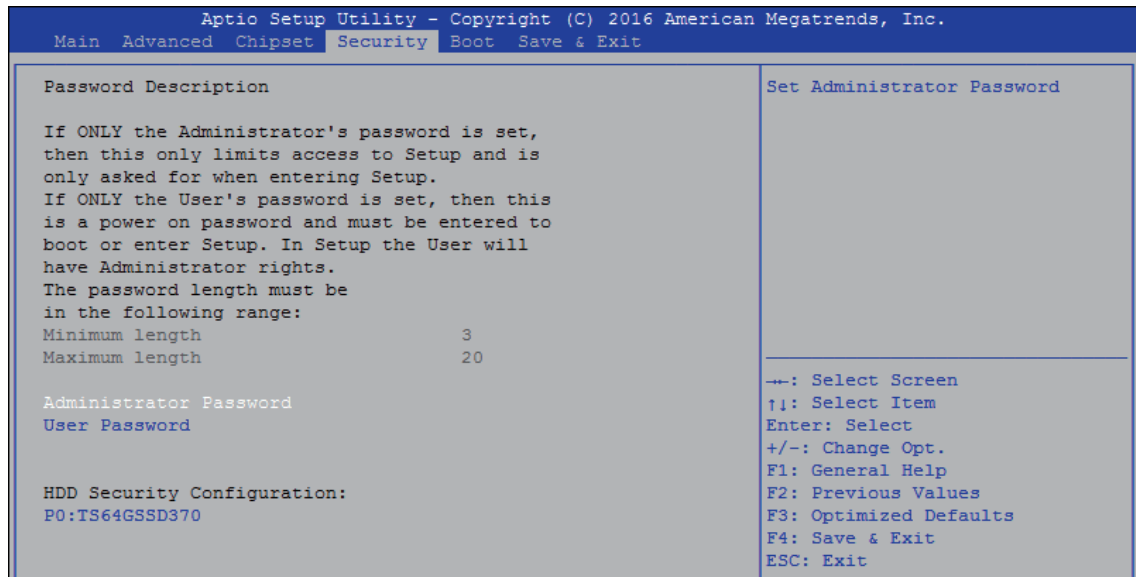

Figure 4-5: BIOS Security Menu

### Administrator Password

Set administrator password.

### User Password

Set user password.

### 4.5.1 HDD Security Configuration

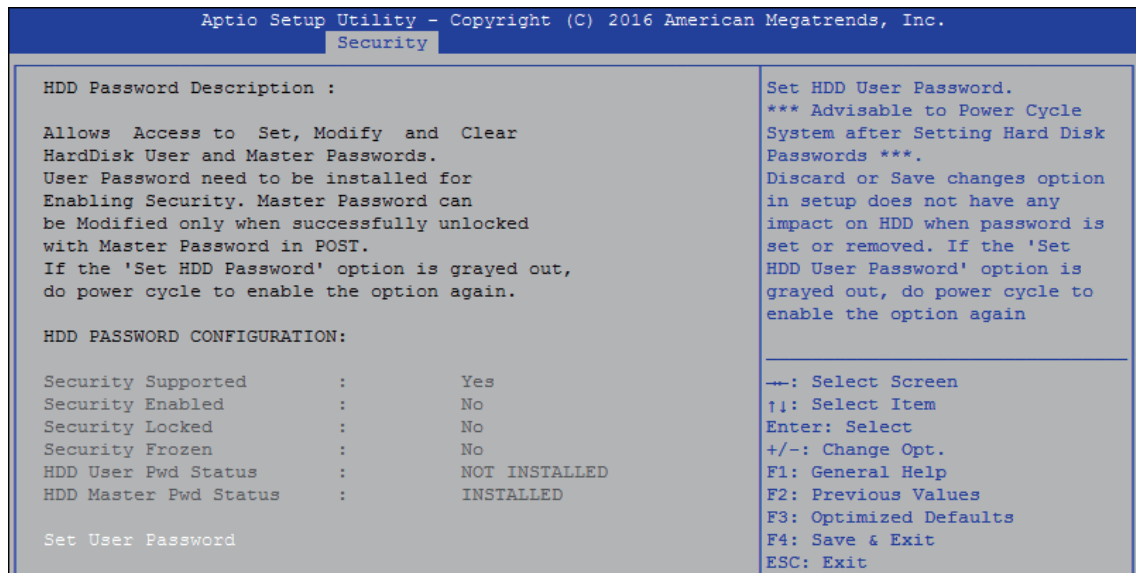

Figure 4-5-1: HDD Security Settings

### Set User Password

Set HDD user password.

\*\*\* Advisable to power cycle system after setting hard disk passwords \*\*\*

Discard or save changes option in setup does not have any impact on HDD when password is set or removed. If the 'Set HDD User Password' option is gray, do power cycle to enable the option again.

## 4.6 Boot

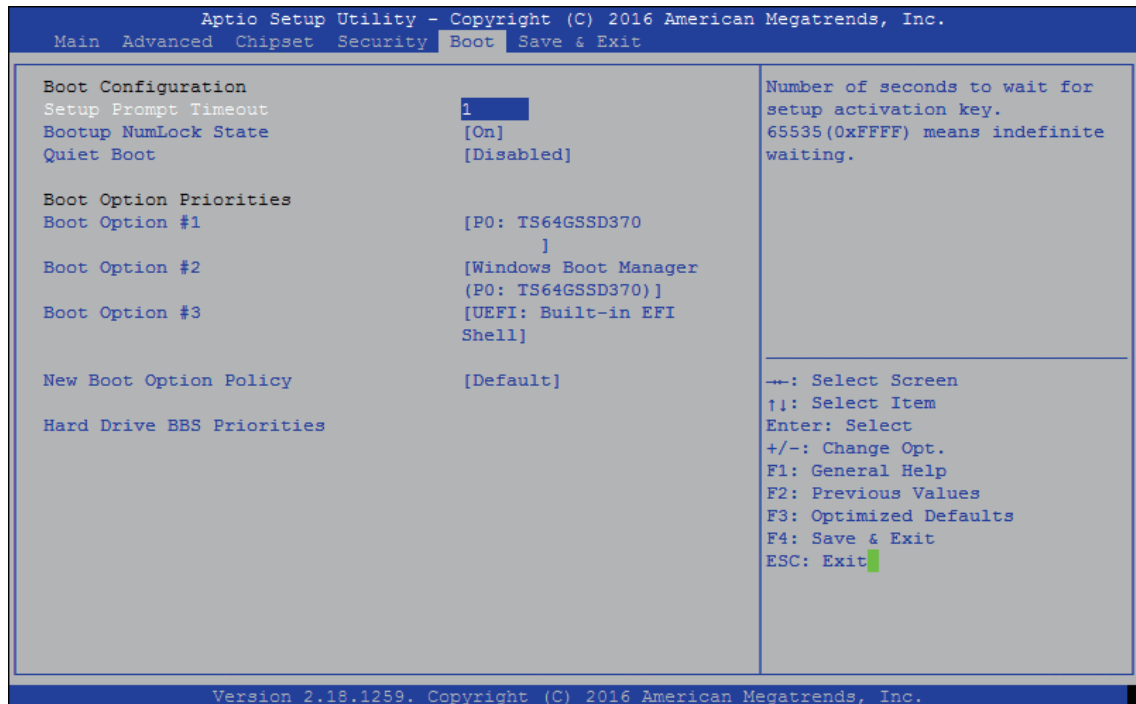

Figure 4-6: BIOS Boot Menu

### Setup Prompt Timeout

Number of seconds to wait for setup activation key. 65535(0xFFFF) means indefinite waiting.

### Bootup NumLock State

Select the keyboard NumLock state.

### Quiet Boot

Enables or disables Quiet Boot option.

### Boot Option

Sets the system boot order.

### New Boot Option Policy

Controls the placement of newly detected UEFI boot options.

### Hard Drive BBS Priorities

Set the order of the Legacy devices in this group.

## 4.7 Save & Exit

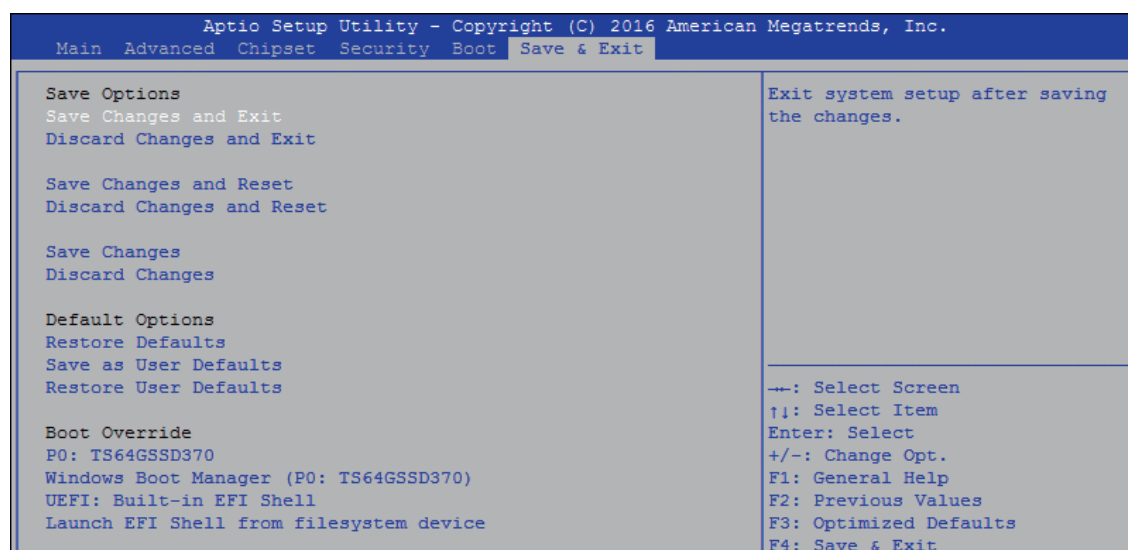

Figure 4-7: Bios Save and Exit Menu

### Save Changes and Exit

Exit system setup after saving the changes.

### Discard Changes and Exit

Exit system setup without saving any changes.

### Save Changes and Reset

Reset the system after saving the changes.

### Discard Changes and Reset

Reset system setup without saving any changes.

### Save Changes

Save changes done so far to any of the setup options.

### Discard Changes

Discard changes done so far to any of the setup options.

### Default Options:

#### Restore Defaults

Restore/load default values for all the setup options.

#### Save as User Defaults

Save the changes done so far as user defaults.

#### Restore User Defaults

Restore the user defaults to all the setup options.

# A

## APPENDIX A : Isolated DIO Guide

### A.1 Function Description

The ECS-9200 offers two 16-bit DIO (8-DI/8-DO) 20-pin terminal block connector. Each bit of DI and DO equipped with a photo-coupler for isolated protection. All IO pins are fixed by Hardware design and cannot change in/out direction in runtime process. The definition is listed as follows:

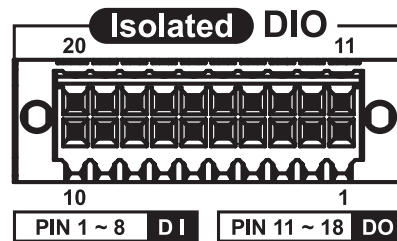

Pin No.	Definition	Description	Pin No.	Definition	Description
1	EXT_IN0	DI0	11	EXT_OUT0	DO0
2	EXT_IN1	DI1	12	EXT_OUT1	DO1
3	EXT_IN2	DI2	13	EXT_OUT2	DO2
4	EXT_IN3	DI3	14	EXT_OUT3	DO3
5	EXT_IN4	DI4	15	EXT_OUT4	DO4
6	EXT_IN5	DI5	16	EXT_OUT5	DO5
7	EXT_IN6	DI6	17	EXT_OUT6	DO6
8	EXT_IN7	DI7	18	EXT_OUT7	DO7
9	DI_COM	DI COM	19	Reserved	NC
10	EGND	DIO GND	20	E24V	External 24V DC

## A.2 DIO Signal Circuit

DI reference circuit:

Sink Mode (NPN)

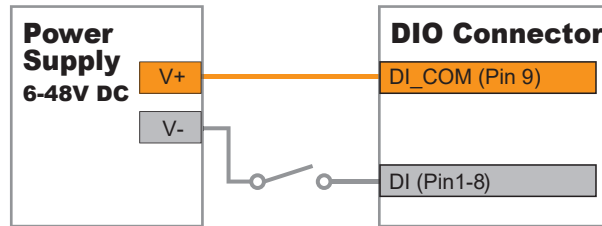

Source Mode (PNP)

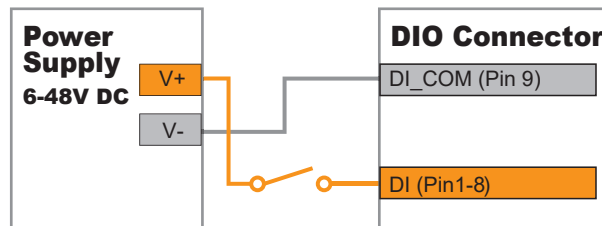

DO reference circuit:

Sink Mode  
(NPN, Default)

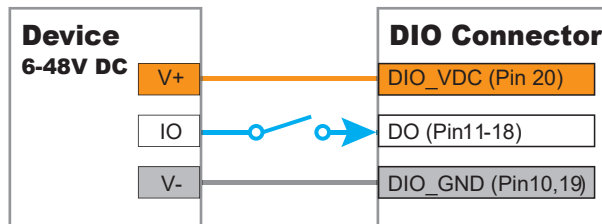

Source Mode  
(PNP)

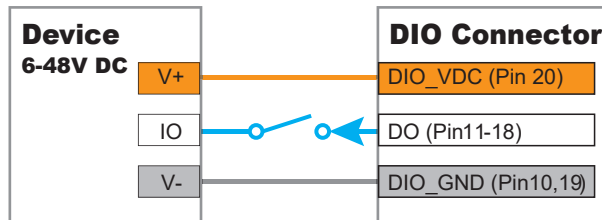

## A.3 Software Package contain

Distribution folder include x32 and x64 versions, use batch file for installation. Win7\_64.bat included Windows Update packages which driver required (OS need to Restart after installing).

If the OS version is Windows 8/8.1/10 the batch file Win8\_32.bat, Win8\_64.bat, Win10\_32.bat, and Win10\_64.bat will install Framework 3.5 distribution for the sample utility. If Source code compile by Framework 4 it doesn't need to install above batch file.



Run batch file as Administrator. Runtime folder include head file for software developer or System Integration. Sample folder include Sample program, Driver package, and Driver API library. Source folder include Sample program source code that compile on Visual Studio 2008.

- 📁 Distribution
- 📁 Runtime
- 📁 Sample
- 📁 Source
- ⚙️ Win7\_64.bat
- ⚙️ Win8\_32.bat
- ⚙️ Win8\_64.bat
- ⚙️ Win10\_32.bat
- ⚙️ Win10\_64.bat

This driver support to 32bit and 64bit version that are Windows 7 above. Please make Sure you OS before you install it

## A.4 DIO Demo Tool

Operation on DIO demo tool utility.

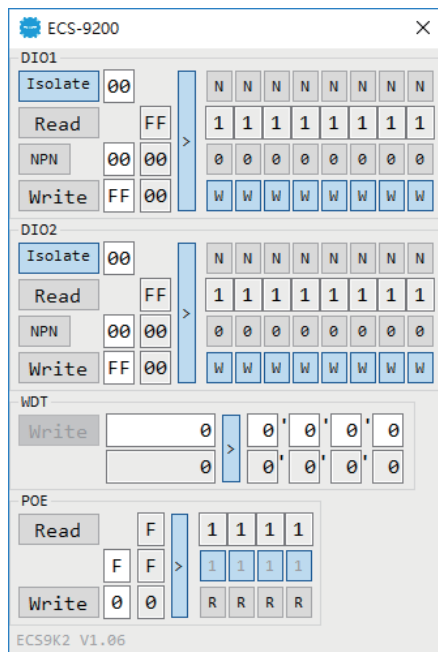

Execute DIO Demo tool (ECS9K2.exe).

- ⚙️ drv.dll
- ⚙️ drv32.sys
- ⚙️ drv64.sys
- ⚙️ ECS9K2.dll
- ⚙️ ECS9K2

Operation on DIO Demo tool utility.

Click “Isolate” checked button for isolate / non-isolated DIO setup (customized version);

Click “N” / ”P” checked button for DI NPN / PNP setup (or change textbox value);

Click “NPN” / “PNP” checked button for DO NPN / PNP setup;

Click “Read” button to get value;

Input any number in Write and Write Mask textbox, and click “Write” Button to set value;

Click “Stop” button to cancel WDT (watchdog timer) counter.

# B

## APPENDIX B : Software Functions

### B.1 ECS9K2.DII API

In Runtime folder, on ECS9K2.h:

**BOOL Initial(BYTE Isolate\_Type, BYTE DIO\_NPN);**

Install driver and initial machine for DIO access

Isolate\_Type: DIO Isolate Type

1: Isolated DIO; 0: Non-Isolated DIO

DIO\_NPN: DIO NPN mode

1: PNP (Source) mode for European rule; 0: NPN (Sink) mode for Japanese rule

Return:

TRUE (1): Success; FALSE (0): Fail (Install error (privilege error, or driver not work), or Initial error, or Parameter format error)

**BOOL GetDI1(BYTE \*DI);**

Get DIO1 input

DI: DIO1 input (DI[7:0])

Return:

TRUE (1): Success; FALSE (0): Fail (driver not work, or hardware problem)

**BOOL SetDO1(BYTE DO);**

Set DIO1 output

DO: DIO1 output (DO[7:0])

Return:

TRUE (1): Success; FALSE (0): Fail (driver not work, or hardware problem)

**BOOL GetDO1(BYTE \*DO);**

Get DIO1 output

DO: DIO1 output (DO[7:0])

Return:

TRUE (1): Success; FALSE (0): Fail (driver not work, or hardware problem)

**BOOL GetDI2(BYTE \*DI);**

Get DIO2 input

DI: DIO2 input (DI[7:0])

Return:

TRUE (1): Success; FALSE (0): Fail (driver not work, or hardware problem)

**BOOL SetDO2(BYTE DO);**

Set DIO2 output

DO: DIO2 output (DO[7:0])

Return:

TRUE (1): Success; FALSE (0): Fail (driver not work, or hardware problem)

**BOOL GetDO2(BYTE \*DO);**

Get DIO2 output

DO: DIO2 output (DO[7:0])

Return:

TRUE (1): Success; FALSE (0): Fail (driver not work, or hardware problem)

**BOOL GetWDT(DWORD \*WDT);**

Get watchdog timer

WDT: Watchdog timer

Return:

TRUE (1): Success; FALSE (0): Fail (driver not work, or hardware problem)

**BOOL SetWDT(DWORD WDT);**

Set watchdog timer

WDT: Watchdog timer

Return:

TRUE (1): Success; FALSE (0): Fail (driver not work, or hardware problem, or parameter format error)

**BOOL CancelWDT();**

Cancel watchdog timer

WDT: Watchdog timer

Return:

TRUE (1): Success; FALSE (0): Fail (driver not work, or hardware problem)

**BOOL GetPOEConfig(BYTE \*Mask);**

Get POE enable/disable configuration

Mask: POE enable mask (Mask[7:0])

Return:

TRUE (1): Success; FALSE (0): Fail (driver not work, or hardware problem)

**BOOL SetPOEConfig(BYTE Mask);**

Set POE enable/disable configuration

Mask: POE enable mask (Mask[7:0])

Return:

TRUE (1): Success; FALSE (0): Fail (driver not work, or hardware problem)

**BOOL GetPOE(BYTE \*POE);**

Get POE on/off setup

POE: POE switch (POE[7:0])

Return:

TRUE (1): Success; FALSE (0): Fail (driver not work, or hardware problem)

**BOOL SetPOE(BYTE POE);**

Set POE on/off setup

POE: POE switch (POE[7:0])

Return:

TRUE (1): Success; FALSE (0): Fail (driver not work, or hardware problem)

**BOOL GetDIO1Config(BYTE \*Isolate\_Type, BYTE \*DI\_NPN, BYTE \*DO\_NPN);**

Get DIO1 configuration

Isolate\_Type: DIO1 Isolate Type

1: Isolated DIO; 0: Non-Isolated DIO

DI\_NPN: DIO1 input NPN mode (DI\_NPN[7:0])

1: PNP (Source) mode for European rule; 0: NPN (Sink) mode for Japanese rule

DO\_NPN: DIO1 output NPN mode

1: PNP (Source) mode for European rule; 0: NPN (Sink) mode for Japanese rule

Return:

TRUE (1): Success; FALSE (0): Fail (driver not work, or hardware problem)

**BOOL Set DIO1Config(BYTE Isolate\_Type, BYTE DI\_NPN, BYTE DO\_NPN);**

Set DIO1 configuration

Isolate\_Type: DIO1 Isolate Type

1: Isolated DIO; 0: Non-Isolated DIO

DI\_NPN: DIO1 input NPN mode (DI\_NPN[7:0])

1: PNP (Source) mode for European rule; 0: NPN (Sink) mode for Japanese rule

DO\_NPN: DIO1 output NPN mode

1: PNP (Source) mode for European rule; 0: NPN (Sink) mode for Japanese rule

Return:

TRUE (1): Success; FALSE (0): Fail (driver not work, or hardware problem)

**BOOL GetDIO2Config(BYTE \*Isolate\_Type, BYTE \*DI\_NPN, BYTE \*DO\_NPN);**

Get DIO2 configuration

Isolate\_Type: DIO2 Isolate Type

1: Isolated DIO; 0: Non-Isolated DIO

DI\_NPN: DIO2 input NPN mode (DI\_NPN[7:0])

1: PNP (Source) mode for European rule; 0: NPN (Sink) mode for Japanese rule

DO\_NPN: DIO2 output NPN mode

1: PNP (Source) mode for European rule; 0: NPN (Sink) mode for Japanese rule

Return:

TRUE (1): Success; FALSE (0): Fail (driver not work, or hardware problem)

**BOOL Set DIO2Config(BYTE Isolate\_Type, BYTE DI\_NPN, BYTE DO\_NPN);**

Set DIO2 configuration

Isolate\_Type: DIO2 Isolate Type

1: Isolated DIO; 0: Non-Isolated DIO

DI\_NPN: DIO2 input NPN mode (DI\_NPN[7:0])

1: PNP (Source) mode for European rule; 0: NPN (Sink) mode for Japanese rule

DO\_NPN: DIO2 output NPN mode

1: PNP (Source) mode for European rule; 0: NPN (Sink) mode for Japanese rule

Return:

TRUE (1): Success; FALSE (0): Fail (driver not work, or hardware problem)

# C

## APPENDIX C : RAID Installation Guide

### C.1 SATA Mode for RAID

Please select SATA device to RAID mode on BIOS menu.  
Advanced → SATA Configuration → SATA Mode Selection

Main	Advanced	Chipset	Boo	Security	Save & Exit	
SATA Controller(s)					[Enabled]	Item Specific Help
SATA Model Selection					[AHCI]	

### C.2 OS Installation

ECS-9200 is featured with six SATA, include two internal SATA, three mSATA and one CFAST.

You can select one of SATA ports for OS installation

We used CFAST card for Windows 10 OS installation as an example.

### C.3 Install All Device Drivers of ECS-9200 System

The instructions are as follows:

1. Install Chipset driver
2. Install Network driver
3. Install ME driver (if available)
4. Install Audio driver
5. Install VGA driver

## C.4 Install “Intel Rapid Storage Technology” Software

You can get the latest information and the software directly from Intel website.

[http://www.intel.com/p/en\\_US/support/highlights/chpsts/imsm](http://www.intel.com/p/en_US/support/highlights/chpsts/imsm)

The RAID environment has been done if you completed the steps above.

## C.5 Insert SATA HDD for RAID 1

Please notice, you can use six SATA ports for SATA HDD, except for the CFast port and mSATA slot.

## C.6 Create RAID Volume on “Rapid Storage Technology” Software

ECS-9200/9100 is featured with four SATA HDDs for RAID volume, so there are three options for choose on this page. Let’s take RAID 1 as example, please select “RAID 1”.



## C.7 Disk Management : Partition the Disk

After RAID 1 volume created, you can see the figure of SATA device allocation.

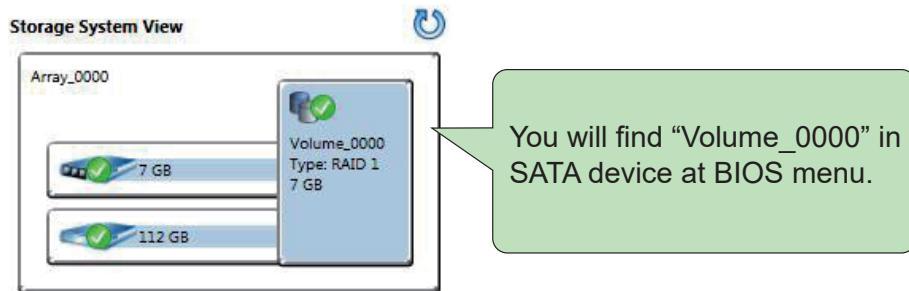

To start Disk Management tool, select "initialize disk."

Then add "Logical Device" for Windows access.

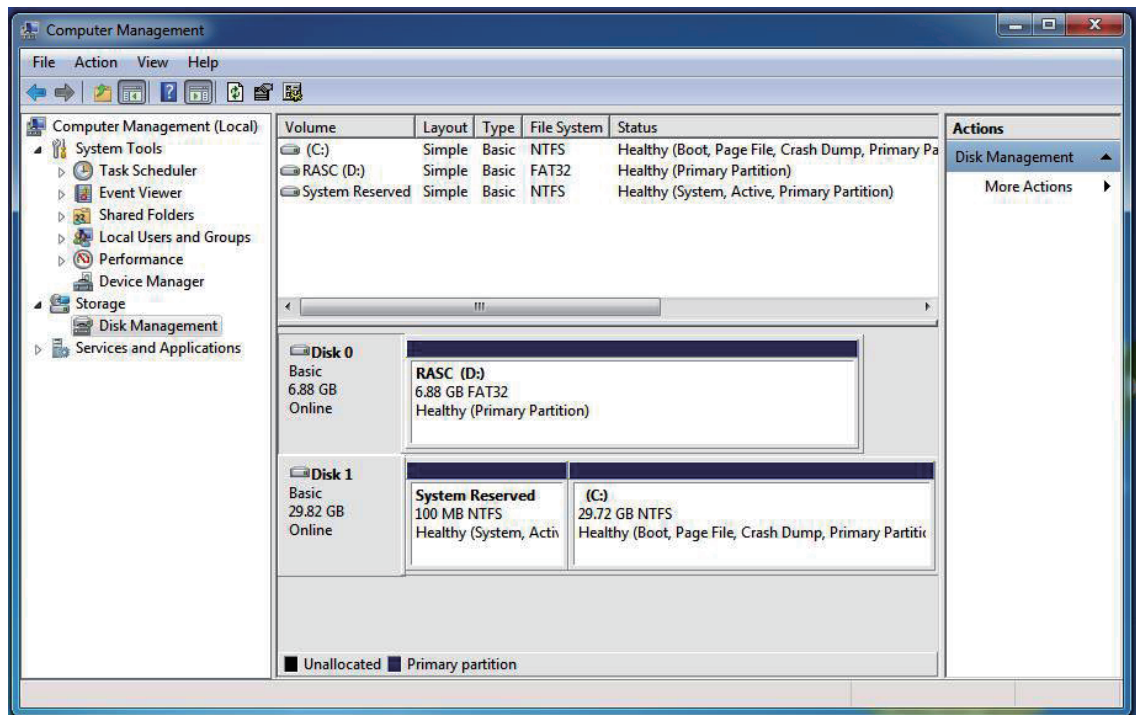

## C.8 If One SATA HDD on RAID Volume is Out-of-use

After RAID 1 volume created, you can see the figure of SATA device allocation.

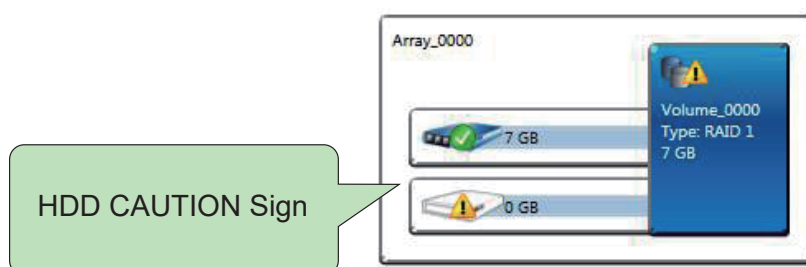

## C.9 Recovery and Auto Re-build When Use the **SAME** RAID HDD

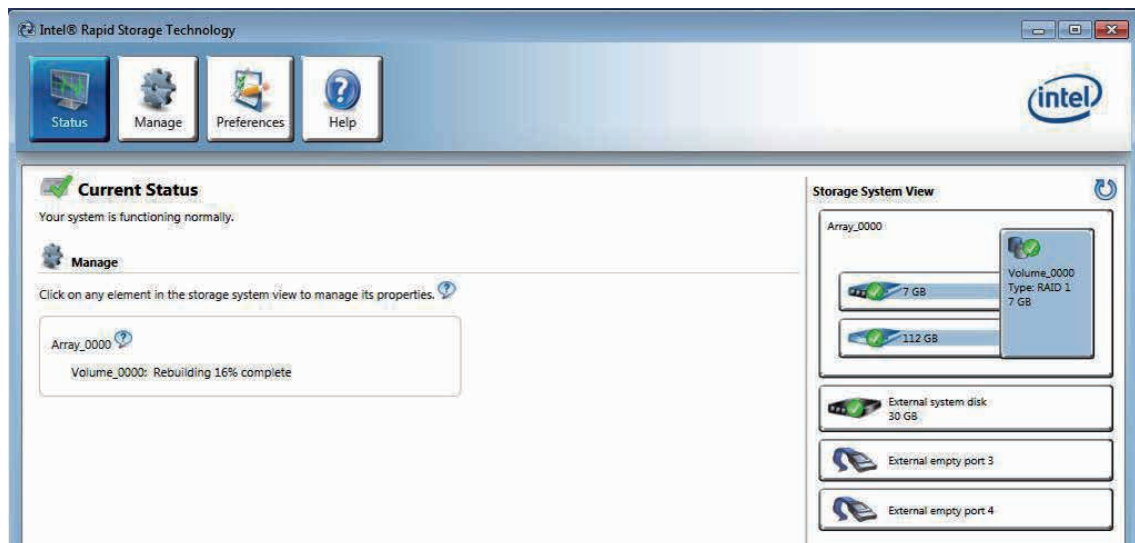

## C.10 Recovery and Auto Re-build When Use **DIFFERENT** RAID HDD

There is a warning will pop-up to ask you if the disk is not a member of original RAID volume.

If you press “Rebuild”, it will replace the broken SATA HDD to the last one SATA HDD of RAID volume.

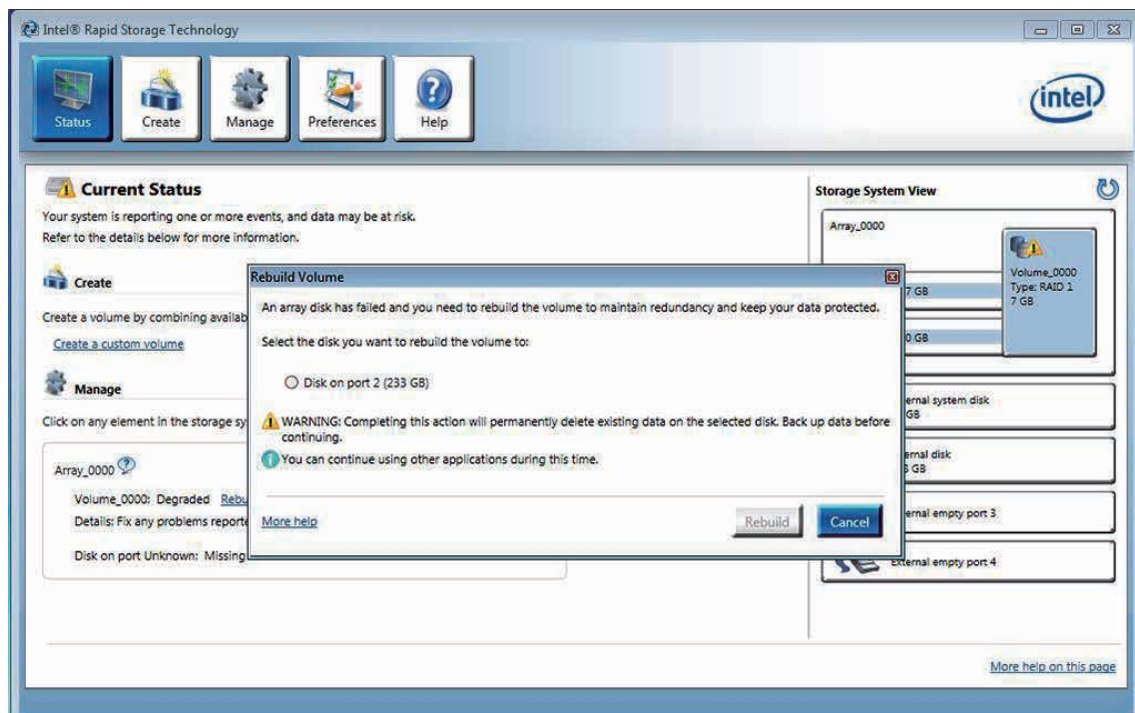



# D

## APPENDIX D : Power Consumption

Testing Board	ECS-9200
RAM	16GB x 2
USB-1	USB Keyboard Logitech K120
USB-2	USB Mouse Microsoft 1113
USB-3	USB Flash Transecnd 3.0 8GB
USB-4	USB Flash Transecnd 3.0 8GB
CFAST	innodisk CFast 3ME3 64GB
SATA 0	Transcend SSD370 64GB
SATA 1	TOSHIBA SSD THNS064GE4BBDC 64GB
LAN 1 (i219)	1.0 Gbps
LAN 2 (i210)	1.0 Gbps
LAN 3 (i210)	1.0 Gbps
LAN 4 (i210)	1.0 Gbps
LAN 5 (i210)	1.0 Gbps
LAN 6 (i210)	1.0 Gbps
Graphics Output	DVI
Power Plan	Balance (Windows8.1 Power Plan)
Power Source	Chroma 62006P-100-25

## D.1 Intel® Core™ i7-6700@3.40GHz (8M Cache, 4.0 GHz)

### Power on and boot to Win8.1 64-bit

CPU	Power Input	Sleep Mode		Idle Status : CPU usage less 3%	
		Max Current	Max Consumption	Max Current	Max Consumption
Core™ i7-6700	06V	0.846A	05.08W	3.411A	20.47W
Core™ i7-6700	09V	0.554A	04.99W	2.311A	20.80W
Core™ i7-6700	12V	0.409A	04.91W	1.732A	20.78W
Core™ i7-6700	24V	0.286A	06.86W	0.918A	22.03W
Core™ i7-6700	36V	0.250A	09.00W	0.663A	23.87W

CPU	Power Input	Run 100% CPU usage without 3D		Run 100% CPU usage with 3D	
		Max Current	Max Consumption	Max Current	Max Consumption
Core™ i7-6700	06V	9.940A	59.64W	12.649A	75.89W
Core™ i7-6700	09V	6.389A	57.50W	8.164A	73.48W
Core™ i7-6700	12V	4.778A	57.34W	6.079A	72.95W
Core™ i7-6700	24V	2.424A	58.18W	3.084A	74.02W
Core™ i7-6700	36V	1.676A	60.34W	2.149A	77.36W

## D.2 Intel® Core™ i5-6500TE@2.30GHz (6M Cache, 3.30 GHz)

### Power on and boot to Win8.1 64-bit

CPU	Power Input	Sleep Mode		Idle Status : CPU usage less 3%	
		Max Current	Max Consumption	Max Current	Max Consumption
Core™ i5-6500TE	06V	0.839A	05.03W	3.194A	19.16W
Core™ i5-6500TE	09V	0.542A	04.88W	2.106A	18.95W
Core™ i5-6500TE	12V	0.401A	04.81W	1.572A	18.86W
Core™ i5-6500TE	24V	0.280A	06.72W	0.868A	20.83W
Core™ i5-6500TE	36V	0.245A	08.82W	0.628A	22.61W

CPU	Power Input	Run 100% CPU usage without 3D		Run 100% CPU usage with 3D	
		Max Current	Max Consumption	Max Current	Max Consumption
Core™ i5-6500TE	06V	5.493A	32.96W	7.783A	46.70W
Core™ i5-6500TE	09V	3.502A	31.52W	5.037A	45.33W
Core™ i5-6500TE	12V	2.602A	31.22W	3.696A	44.35W
Core™ i5-6500TE	24V	1.410A	33.84W	1.941A	46.58W
Core™ i5-6500TE	36V	0.989A	35.60W	1.337A	48.13W

## D.3 Intel® Core™ i3-6100@3.70GHz (3M Cache, 3.70 GHz)

### Power on and boot to Win8.1 64-bit

CPU	Power Input	Sleep Mode		Idle Status : CPU usage less 3%	
		Max Current	Max Consumption	Max Current	Max Consumption
Core™ i3-6100	06V	0.836A	05.02W	3.264A	19.58W
Core™ i3-6100	09V	0.584A	05.26W	2.263A	20.37W
Core™ i3-6100	12V	0.425A	05.10W	1.652A	19.82W
Core™ i3-6100	24V	0.282A	06.77W	0.900A	21.60W
Core™ i3-6100	36V	0.243A	08.75W	0.648A	23.33W

CPU	Power Input	Run 100% CPU usage without 3D		Run 100% CPU usage with 3D	
		Max Current	Max Consumption	Max Current	Max Consumption
Core™ i3-6100	06V	6.722A	40.33W	8.419A	50.51W
Core™ i3-6100	09V	4.452A	40.07W	5.591A	50.32W
Core™ i3-6100	12V	3.417A	41.00W	4.154A	49.85W
Core™ i3-6100	24V	1.791A	42.98W	2.215A	53.16W
Core™ i3-6100	36V	1.244A	44.78W	1.527A	54.97W

# E

## APPENDIX E : Supported Memory & Storage List

### E.1 Supported Memory List

Testing Board	ECS-9200
Memory Test	Version: 5.1
BurnInTest	V8.1

### Test Item

Channel	Memtest	Bunin	Flash BIOS	Remove Battery
*2	PASS	PASS	PASS	PASS
*1 (Socket 1)	PASS	PASS	N/A	PASS
*1 (Socket 2)	PASS	PASS	N/A	PASS

## NON-ECC

Brand	Info	NOTE & S/N	Test Temp. (Celsius)
Kingston 16GB 2Rx8 2Gx64-Bit PC4-2133	KVR21S15D8/16	BKMM1641607	25°C
		BKMM1661618	25°C
Memxpro 4GB DDR4-2133-15 Wild Temp.	D4S4GHIOFEI	01611170040001	25°C
		01611170040002	25°C
Memxpro 8GB DDR4-2133-15 Wild Temp.	D4S8GHIOFFI	01611150020001	25°C
		01611150020002	25°C
Memxpro 8GB DDR4-2400-17- Wild Temp.	D4S8GHLPGEI	01611170030001	25°C
		01611170030002	25°C
Memxpro 16GB DDR4-2400-17 Wild Temp.	D4SAGHLPGFI	01611150030001	85 °C
		01611150030002	85 °C
Memxpro 16GB DDR4-2400-17	D4SAGHLPGFC	01611150030003	25°C
		01611150030004	25°C
Memxpro 8GB DDR4-2400-17	D4S8GHLPGEC	01611170030003	25°C
		01611170030004	25°C
Memxpro 8GB DDR4-2133-15	D4S8GHIOFFC	01611150020003	25°C
		01611150020004	25°C
Memxpro 4GB DDR4-2133-15	D4S4GHIOFEC	01611170040003	25°C
		01611170040004	25°C
Apacer 8GB DDR4-2400 Wild Temp.	75.CA4GJ.G010B	201646411081	25°C
Apacer 16GB DDR4-2400 Wild Temp.	75.DA4GJ.G010B	201646411074	25°C

## ECC

Brand	Info	NOTE & S/N	Test Temp. (Celsius)
Transcend 8GB ECC Wild Temp.	8G 2Rx8 DDR4 2133 ECCSO	C96644-0001	85 °C
		C96644-0002	85 °C

## E.2 Supported Storage Device List

Type	Brand	Model	Capacity
mSATA	Intel	Intel-310 SSDMAEMC080G2	80GB
	Silicon Power	SP128GIMSA301SW0	128GB
SATA SSD	Transcend	SSD370 TS64GSSD370	64GB
	Memxpro	SSD M3A MI3MA1212802WN	128GB
		SSD M3A MI3MA1225604WN	256GB
		SSD M3A MI3MA1251208WN	512GB
	Innodisk	3MR3-P DRS25-64GD70BCAQC	64GB
Silicon Power	SP128GISSD301RW0	128GB	
SATA HDD	TOSHIBA	MK5055GSX	500GB
M.2 SATA SSD	Memxpro	M3B MD3MB1164GS1WN	64GB
		M3B MD3MB1164GS1SN	64GB
		M3B MD3MB11128D2WN	128GB
		M3B MD3MB11128D2SN	128GB
		M3B MP3MB12256S4WN	256GB
		M3B MP3MB12256S4SN	256GB
M.2 PCIe	Memxpro	ME4ME01128D4SN-M0	128GB
		ME4AE02128D4SNR	128GB
CFast	Transcend	CFX600	32GB
	Silicon Power	SP128GICFX311NV0	128GB

# F

## APPENDIX F : Install Win11 (BIOS TPM Setting)

**Step 1** Click on “Advanced”, then click on “PCH-FW Configuration”

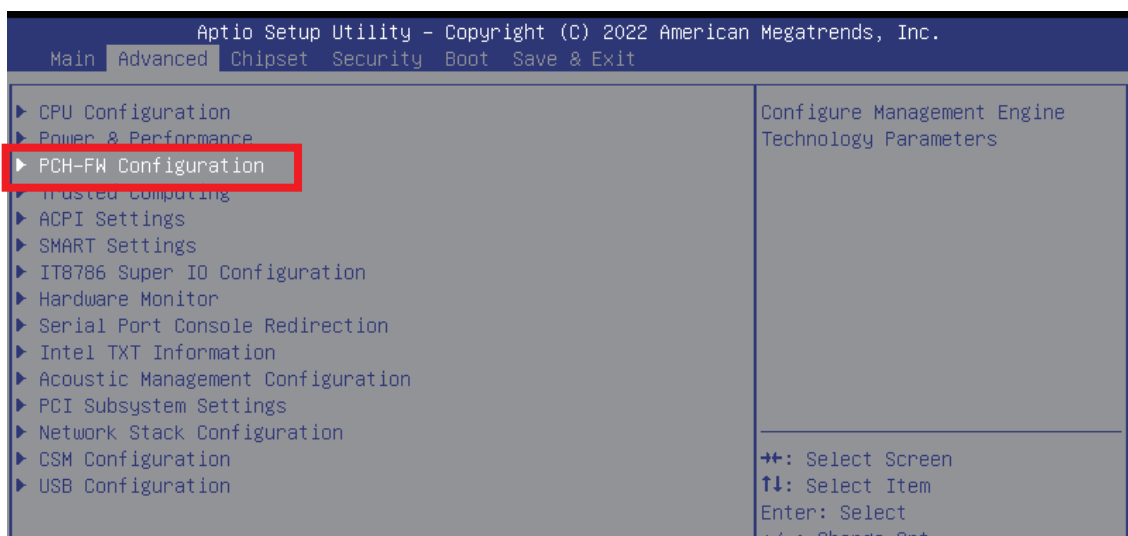

**Step 2** Click on “PTT Configuration”

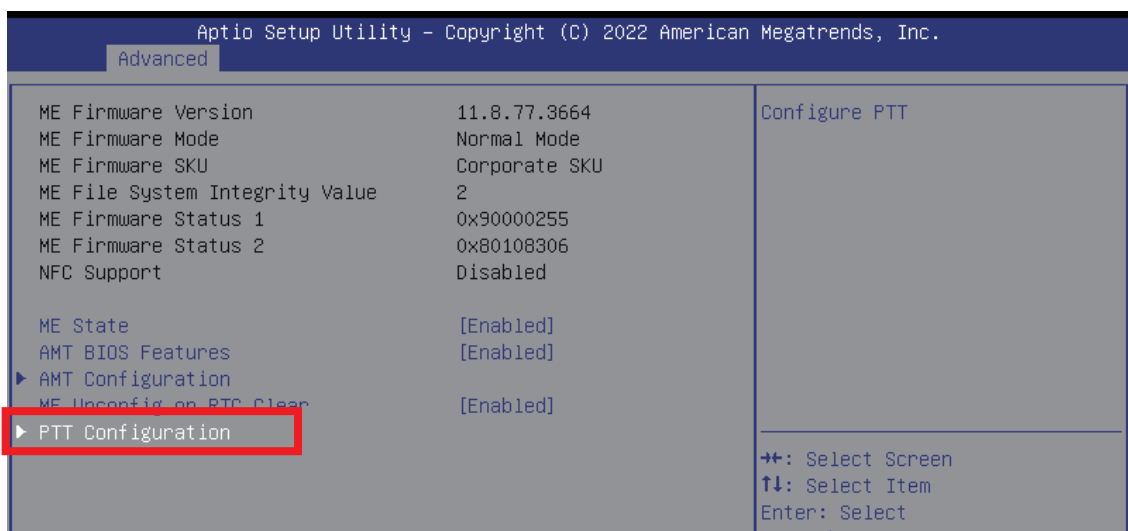



**Step 3** Click on “dTPM” (TPM Device Selection)

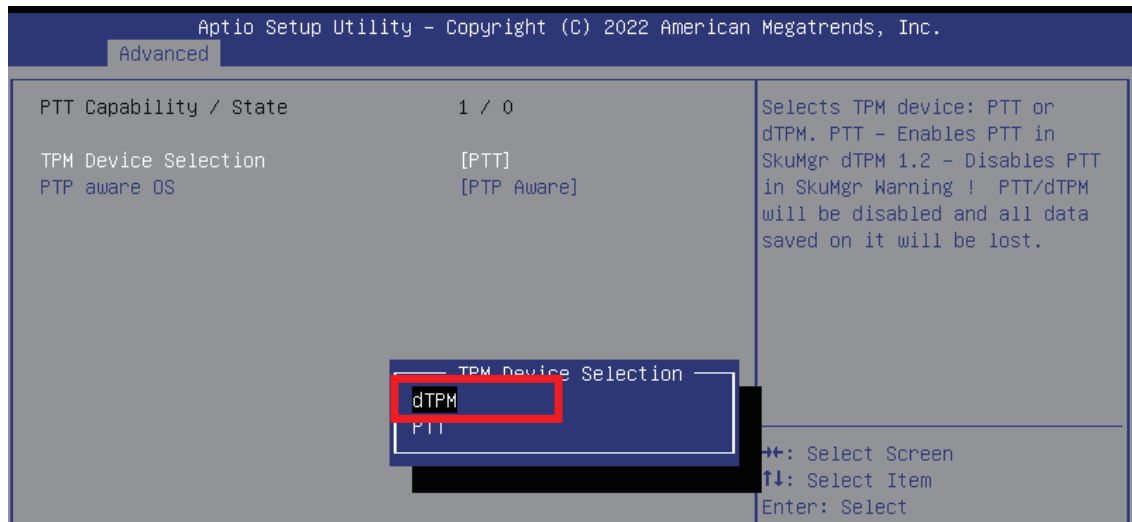

**Step 4** Please save the BIOS settings by pressing F4. Please press Enter when the pop-up window which asks “Save configuration and exit?” appears. The computer will then restart.

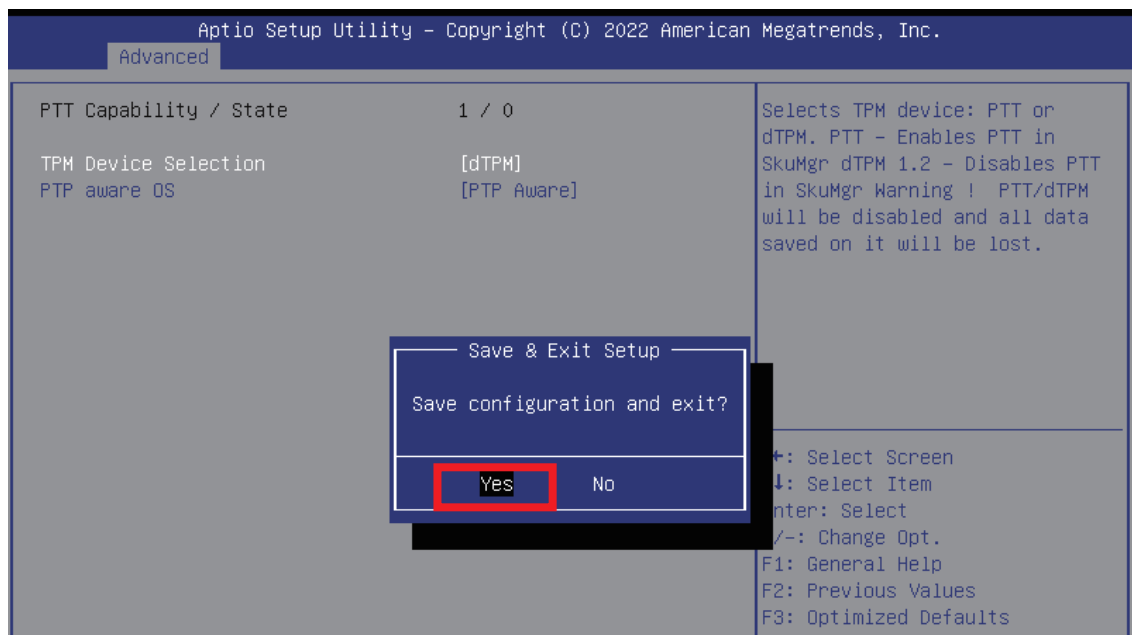

**Step 5** Click on “Trusted Computing”

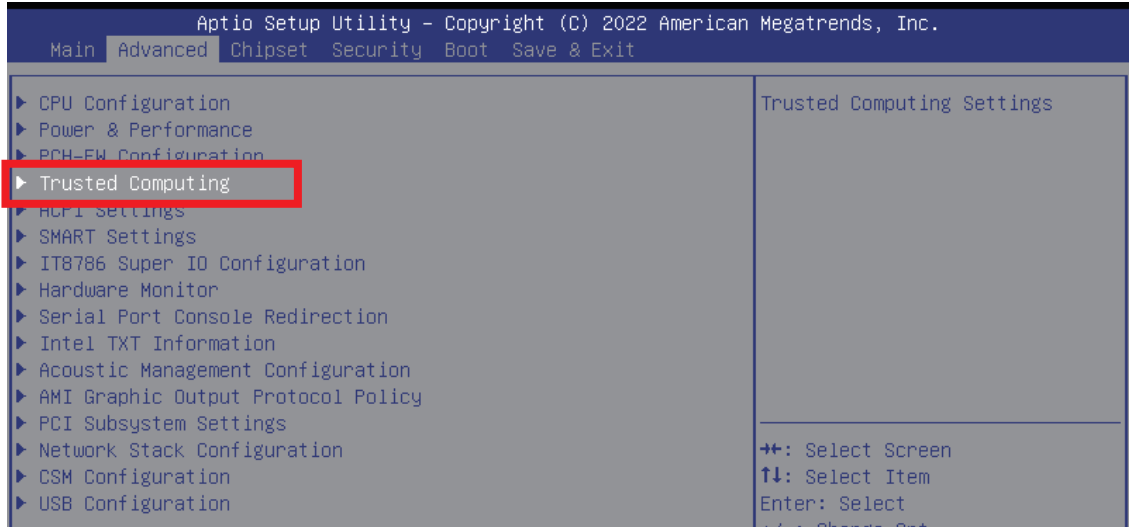

**Step 6** If the window shows “TPM2.0 Device Found Firmware Version:5.62”, then the setting is completed.

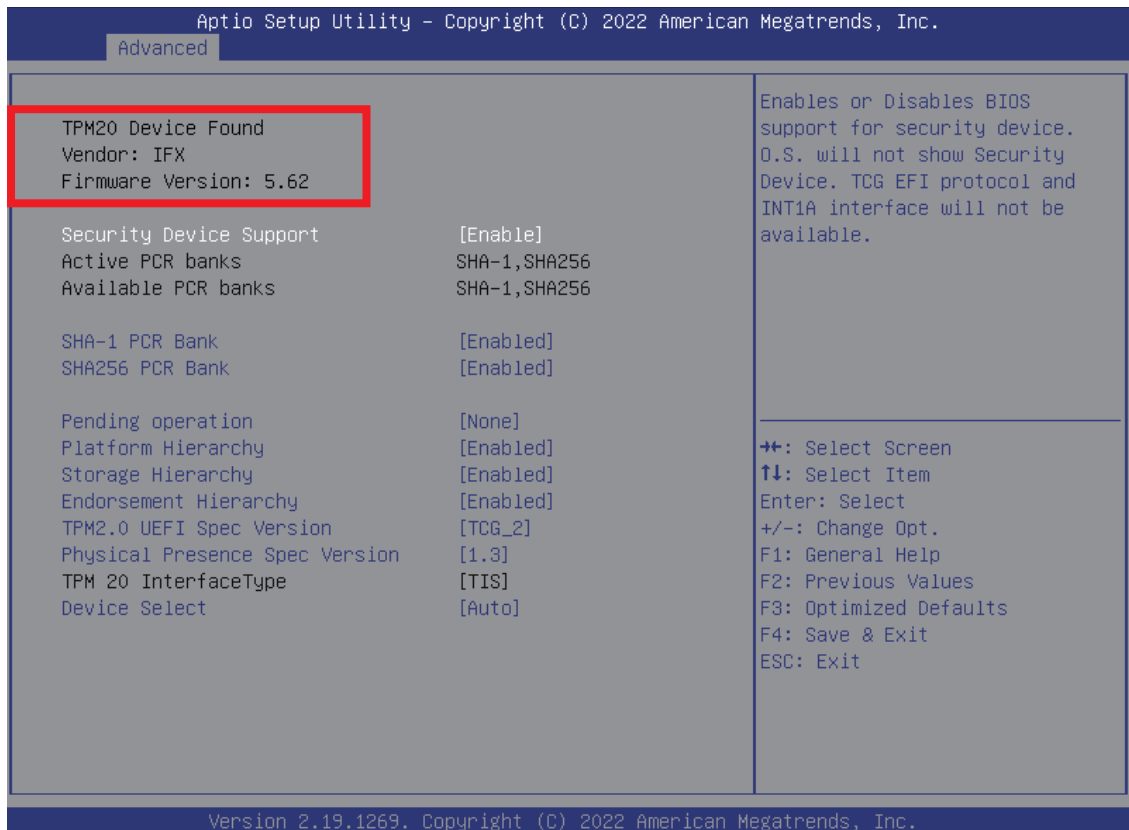

\*\* If more help is needed, please contact Vecow technical support \*\*



For further support information, please visit [www.vecow.com](http://www.vecow.com)

This document is released for reference purpose only.

All product offerings and specifications are subject to change without prior notice.

No part of this publication may be reproduced in any form or by any means, electric, photocopying, or recording, without prior authorization from the publisher.

The rights of all the brand names, product names, and trademarks belong to their respective owners.

© Vecow Co., Ltd. 2023. All rights reserved.